

PORTAVALIGIA SPECIFICO - SPECIFIC CASE HOLDER  
 PORTE-VALESE SPÉCIFIQUE - SPEZIFISCHER KOFFER-TRÄGER  
 PORTA-EQUIPAJE ESPECÍFICO

# APRILIA SPORT CITY ONE 2008

50 - 125 cc

ISTRUZIONI DI MONTAGGIO - MOUNTING INSTRUCTIONS  
 INSTRUCCIONES DE MONTAJE - BAUANLEITUNG - INSTRUCCIONES DE MONTAJE

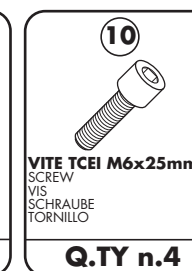
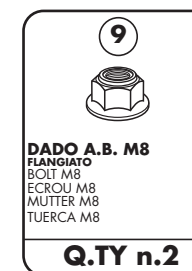
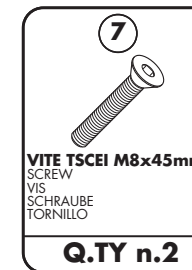
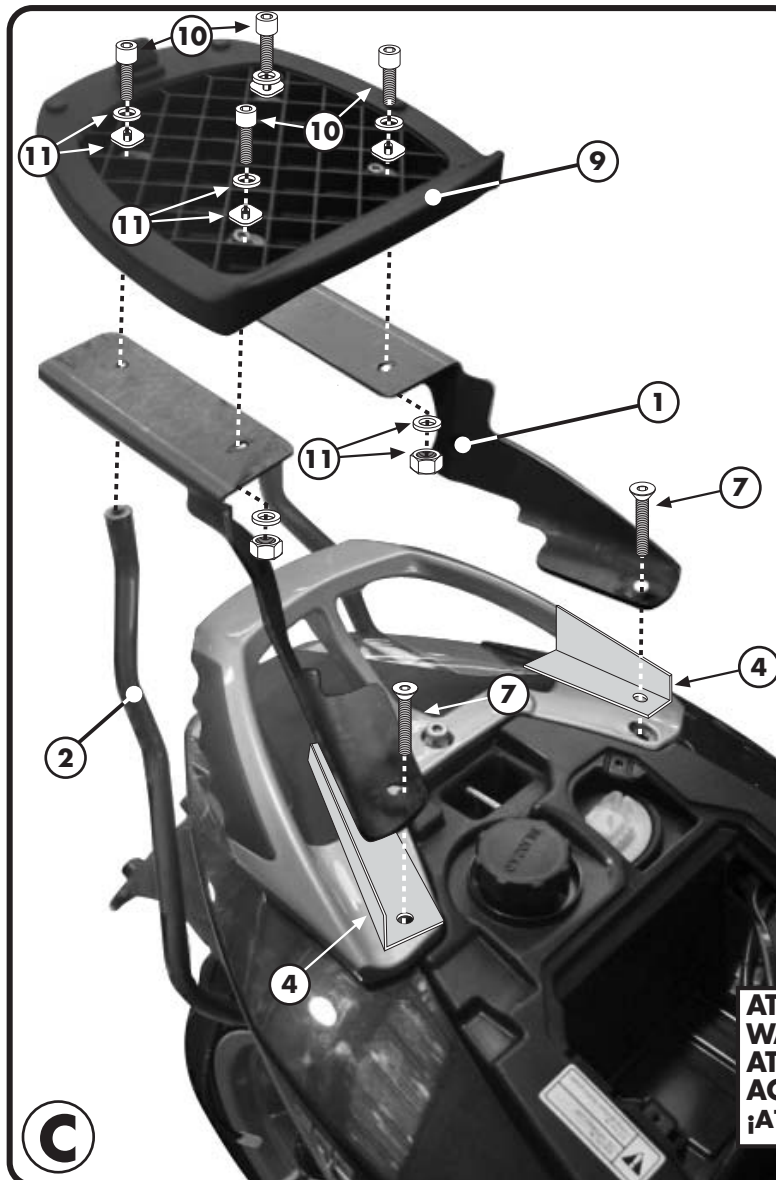
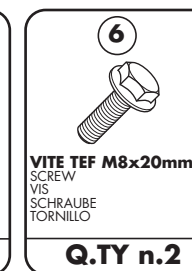
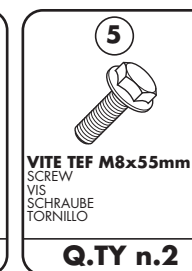
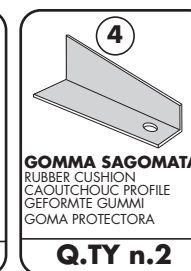
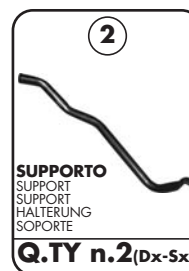
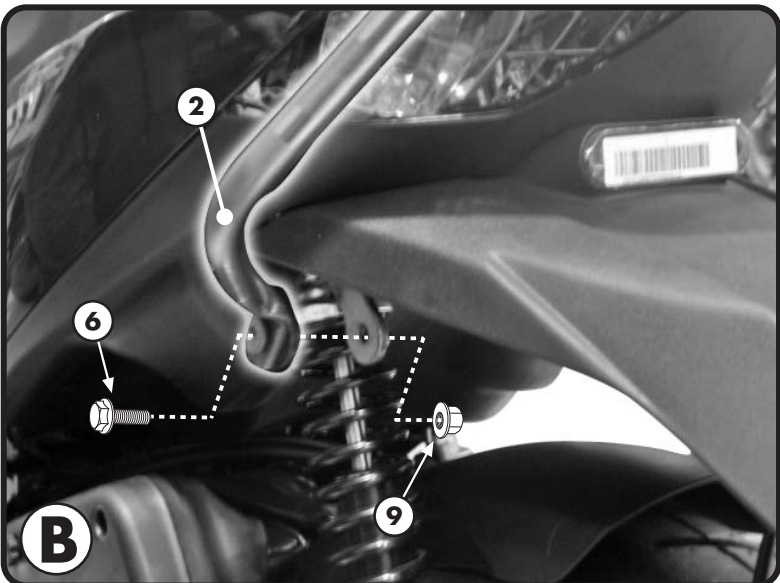
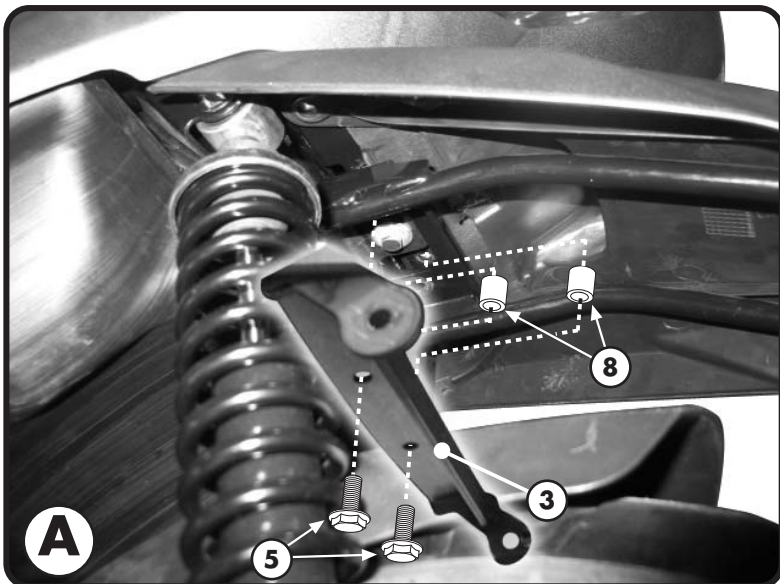

**ATTENZIONE: CARICO MASSIMO 3Kg**  
**WARNING: MAX LOAD, 3Kg.**  
**ATENCIÓN: CARGA MÁXIMA, 3Kg.**  
**ACHTUNG: MAX, 3Kg.**  
**¡ATENCIÓN!: CARGA MÁXIMA, 3Kg.**

PORTAVALIGIA SPECIFICO - SPECIFIC CASE HOLDER  
 PORTE-VALISE SPÉCIFIQUE - SPEZIFISCHER KOFFER-TRÄGER  
 PORTA-EQUIPAJE ESPECIFICO

# APRILIA SPORT CITY ONE 2008

## 50 - 125 cc

ISTRUZIONI DI MONTAGGIO - MOUNTING INSTRUCTIONS  
 INSTRUCTIONS DE MONTAGE - BAUANLEITUNG - INSTRUCCIONES DE MONTAJE

### I ISTRUZIONI DI MONTAGGIO

1. FISSARE IL PONTE AL PARAFANGO COME MOSTRA LA FIGURA A;
2. FISSARE I SUPPORTI N° 2 AL PONTE COME MOSTRA LA FIGURA B;
3. PROCEDERE AL MONTAGGIO DELLE STAFFE ED AL FISSAGGIO DELLA PIASTRA (NON INCLUSA NEL KIT) VERIFICANDO CHE TUTTE LE VITI SIANO BEN SERRATE (VITI M6=9,6Nm - VITI M8=23Nm).

### GB MOUNTING INSTRUCTIONS

1. FIX THE BRIDGE TO THE MUDGUARD AS SHOWN IN PICTURE A;
2. FIX THE SUPPORTS N°2 TO THE BRIDGE AS SHOWN IN PICTURE B;
3. FOLLOW UP WITH THE MOUNTING OF THE ARMS AND SECURING THE PLATE (PLATE NOT INCLUDED IN THE KIT) AND CHECK THAT ALL THE SCREWS ARE WELL TIGHTENED (SCREWS M6=9,6Nm - SCREWS M8=23Nm).

### F INSTRUCTIONS DE MONTAGE

1. FIXER LE PONT AU GARDE-BOUE COMME ILLUSTRE EN PHOTO A;
2. FIXER LES SUPPORTS N°2 AU PONT COMME ILLUSTRE EN PHOTO B;
3. PROCEDER AU MONTAGE DES ETRIERS ET A LA FIXATION DE LA PLATINE (NON INCLUSE DANS LE KIT) EN VERIFIANT LE BON SERRAGE DE TOUTES LES VIS (VIS M6=9,6Nm - VIS M8=23Nm).

### D BAUANLEITUNG

1. BEFESTIGEN SIE DAS VERBINDUNGSROHR AN DEM SCHUTZBLECH WIE IM BILD A GEZEIGT;
2. MONTIEREN SIE DIE HALTERUNGEN NR. 2 AN DER BRÜCKE WIE IM BILD B GEZEIGT;
3. MONTIEREN SIE DIE ARME UND DIE PLATTE (NICHT ENTHALTEN IN DEM KIT). ÜBERPRÜFEN SIE DASS ALLE SCHRAUBEN (SCHRAUBEN M6=9,6 NM - SCHRAUBEN M8=23 NM) FESTGEZOGEN WURDEN.

### ES INSTRUCCIONES DE MONTAJE

1. FIJAR EL PUENTE AL GUARDABARROS COMO SE INDICA EN LA FOTO A;
2. FIJAR LOS SOPORTES N. 2 AL PUENTE COMO SE INDICA EN LA FOTO B;
3. CONTINUAR EFECTUANDO EL MONTAJE DE LOS ESTRIBOS Y EL ANCLAJE DE LA PARRILLA (QUE NO ESTÁ INCLUIDA EN EL KIT) VERIFICAR QUE TODOS LOS TORNILLOS ESTEN BIEN APRETADOS (TORNILLOS M6=9,6NM - TORNILLOS M8=23NM).