

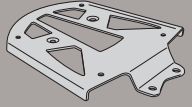

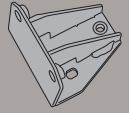

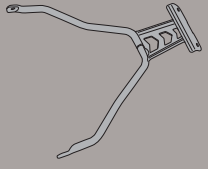
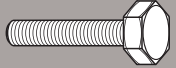

SR2111M - KR2111M

PORTAPACCO SPECIFICO - SPECIFIC HOLDER - PORTE-PAQUET SPÉCIFIQUE - SPEZIFISCHER TRÄGER - PORTA-EQUIPAJE ESPECÍFICO - TRANSPORTADOR ESPECÍFICO

YAMAHA XMAX 400 (2013)



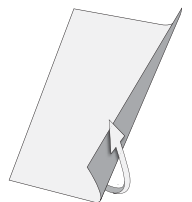

N°	Descrizione	Caratteristiche	Codice	Quantità	
1	Supporto - Support - Support Halteung - Soporte - Apoio	Sp. 3mm	GL2448P	1	
2	Supporto - Support - Support Halteung - Soporte - Apoio	Sp. 3mm	GL2442S	1	
3	Supporto - Support - Support Halteung - Soporte - Apoio	-	-	1	
4	Vite - Screw Vis - Schraube Tornillo - Parafuso	TE M10x70 Passo1,25	1070TES	2	
5	Vite - Screw Vis - Schraube Tornillo - Parafuso	TECF M8x20	820TECF	3	
6	Vite - Screw Vis - Schraube Tornillo - Parafuso	TECF M8x40	840TECF	2	
7	Vite - Screw Vis - Schraube Tornillo - Parafuso	TSCEI M8x20	820TSP	2	
8	Dado - Bolt - Ecrou Mutter - Tuerca - Porca	Auto Bloccante Flangiato M8	8DADIAFLN	4	
9	Dado - Bolt - Ecrou Mutter - Tuerca - Porca	Dado M10 Passo 1.25	10DADIBS	2	



SR2111M - KR2111M

PORTAPACCO SPECIFICO - SPECIFIC HOLDER - PORTE-PAQUET SPÉCIFIQUE - SPEZIFISCHER TRÄGER - PORTA-EQUIPAJE ESPECÍFICO - TRANSPORTADOR ESPECÍFICO

YAMAHA XMAX 400 (2013)

N°	Descrizione	Caratteristiche	Codice	Quantità	
10	Distanziale - Spacer Entretoise - Distanzstueck Distanciador - Espaçador	Ø18x25 Foro 10,5mm	C18L25F10,5T	2	
11	Distanziale - Spacer Entretoise - Distanzstueck Distanciador - Espaçador	Ø18x22 Foro 8,5mm	C18L22F8,5T	2	
12	Rondella - Washer Rondelle - Scheibe Arandela - Arruela	Ø10	10RON	4	
13	Particolari Inclusi Nel Kit Viteria Della Piastra Components Included In The Fitting Kit Of The Plate Pièces Incluses Dans Le Kit De Vis De La Platine Die Einzelnen Teile Sind Bei Montagekit Der Platte Enthalten Despieces Incluidos En El Kit De Anclajes De La Parrilla Explodiu incluído no Kit as âncoras da grelha	-	-	-	-
14	Vite - Screw Vis - Schraube Tornillo - Parafuso	TCEI M6x25	625TCEI	4	
15	Rondella - Washer Rondelle - Scheibe Arandela - Arruela	Ø6	6RON	4	

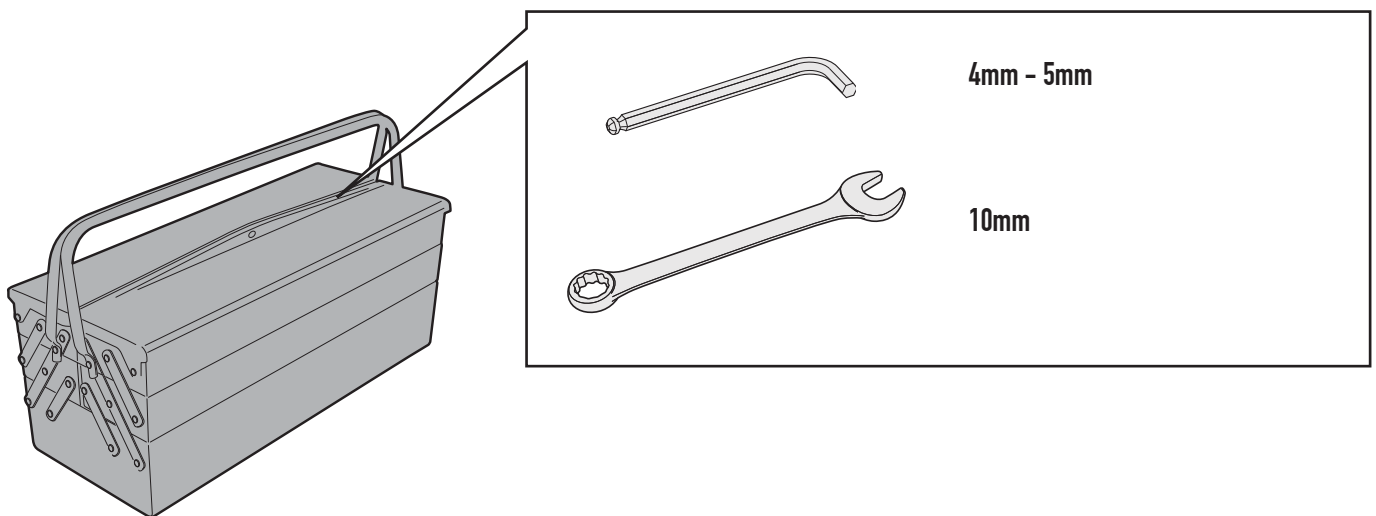

SR2111M - KR2111M

PORTAPACCO SPECIFICO - SPECIFIC HOLDER - PORTE-PAQUET SPÉCIFIQUE - SPEZIFISCHER TRÄGER - PORTA-EQUIPAJE ESPECÍFICO - TRANSPORTADOR ESPECÍFICO

YAMAHA XMAX 400 (2013)

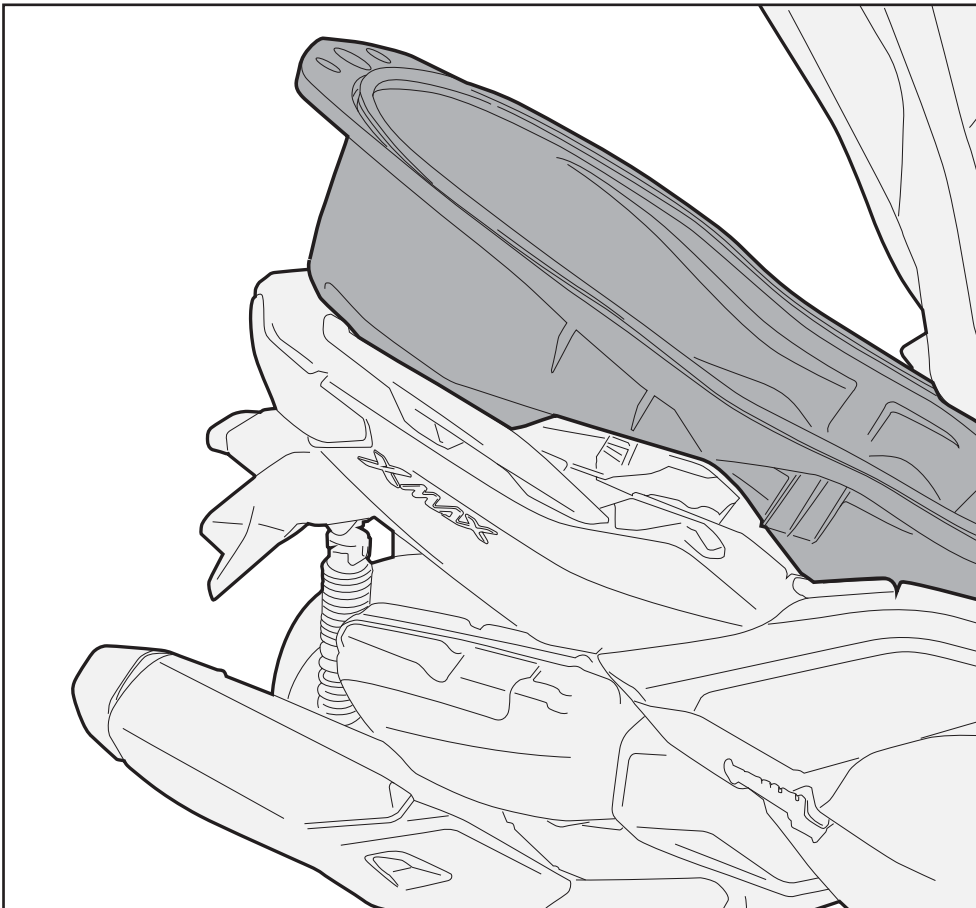
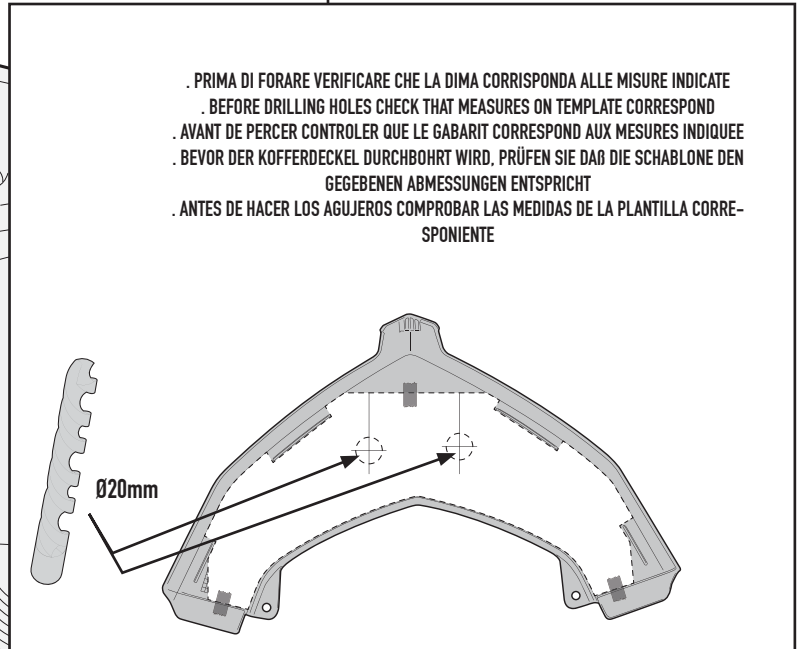
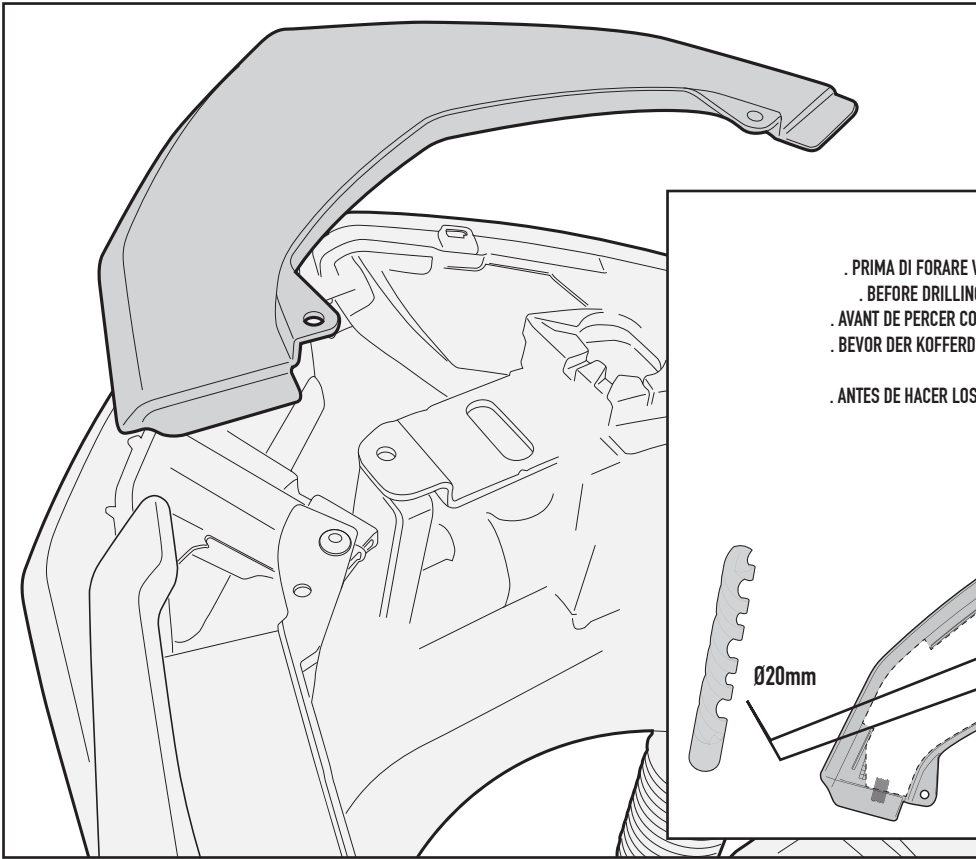

TOGLIERE
REMOVE
ENLEVER
ENTFERNEN
QUITAR
REMOVER

SR2111M - KR2111M

PORTAPACCO SPECIFICO - SPECIFIC HOLDER - PORTE-PAQUET SPÉCIFIQUE - SPEZIFISCHER TRÄGER - PORTA-EQUIPAJE ESPECÍFICO - TRANSPORTADOR ESPECÍFICO

YAMAHA XMAX 400 (2013)

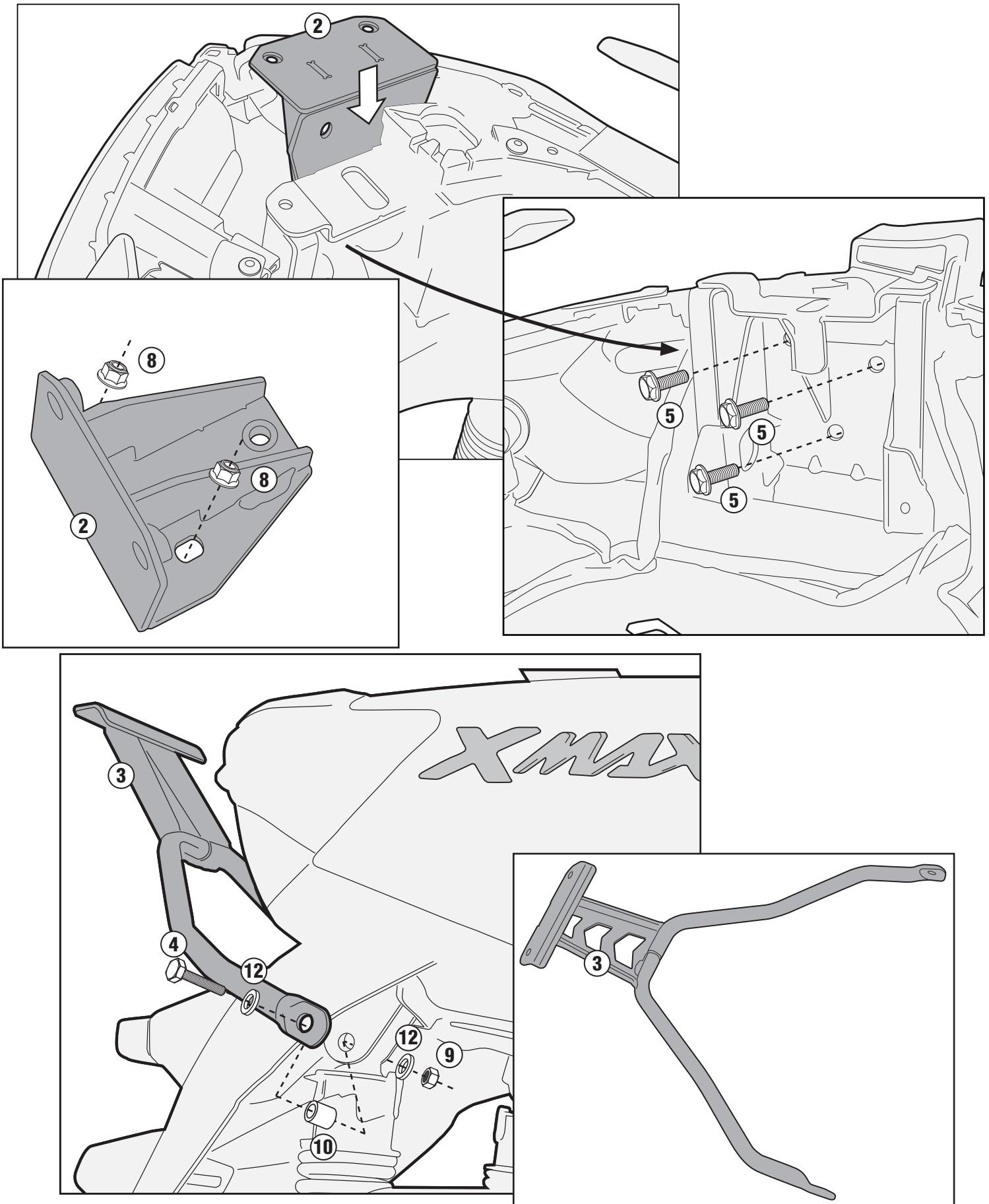

SR2111M - KR2111M

PORTAPACCO SPECIFICO - SPECIFIC HOLDER - PORTE-PAQUET SPECIFIQUE - SPEZIFISCHER TRÄGER - PORTA-EQUIPAJE ESPECÍFICO - TRANSPORTADOR ESPECÍFICO

YAMAHA XMAX 400 (2013)

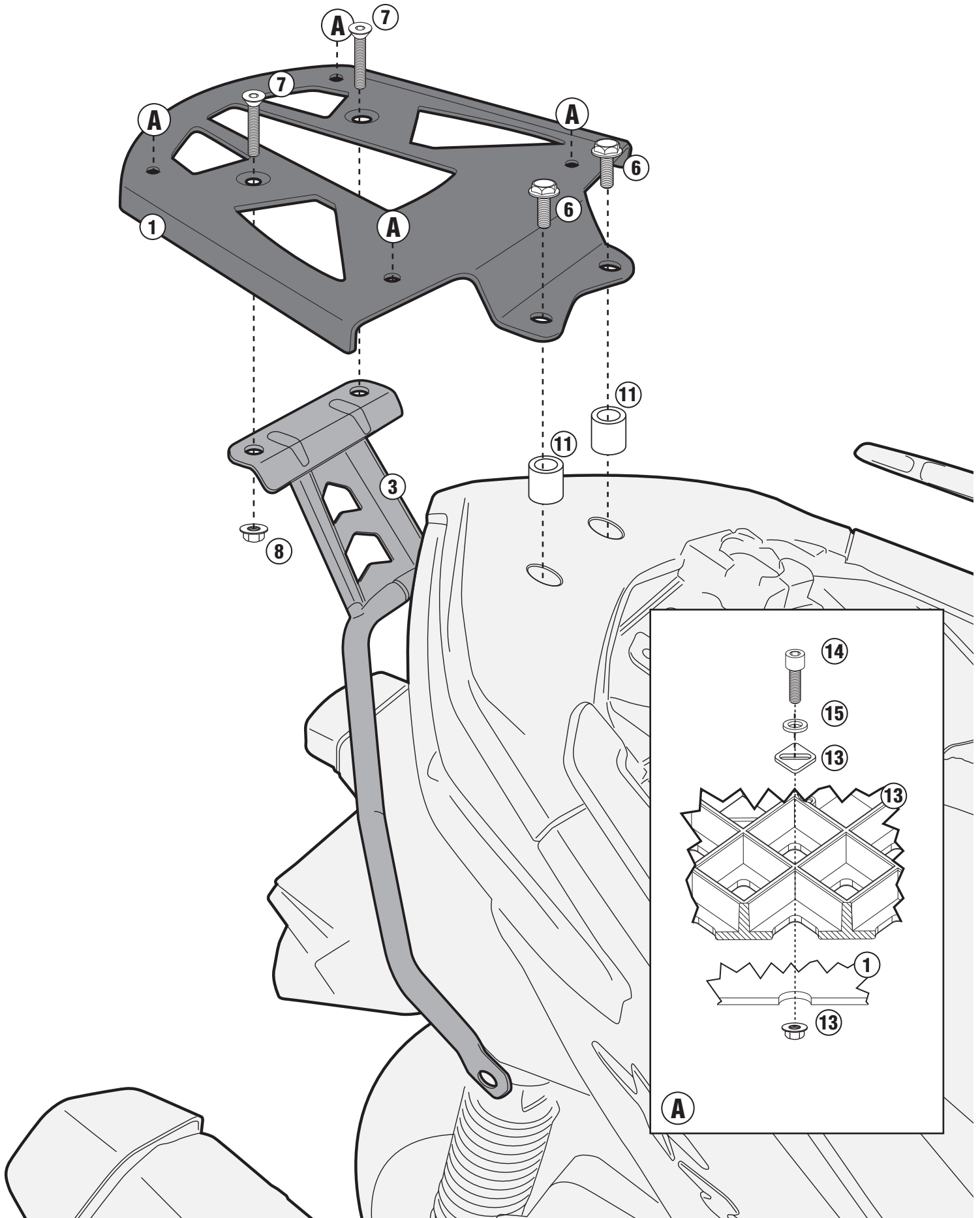

ISTRUZIONI DI MONTAGGIO - MOUNTING INSTRUCTIONS
INSTRUCTIONS DE MONTAGE - BAUANLEITUNG
INSTRUCCIONES DE MONTAJE - INSTRUÇÕES DE MONTAGEM

SR2111M - KR2111M

PORTAPACCO SPECIFICO - SPECIFIC HOLDER - PORTE-PAQUET SPÉCIFIQUE - SPEZIFISCHER TRÄGER - PORTA-EQUIPAJE ESPECÍFICO - TRANSPORTADOR ESPECÍFICO

YAMAHA XMAX 400 (2013)

