

PORTAVALIGIA SPECIFICO - SPECIFIC CASE HOLDER
 PORTE-VALISE SPÉCIFIQUE - SPEZIFISCHER KOFFER-TRÄGER
 PORTA-EQUIPAJE ESPECIFICO

SUZUKI GSR600 06/08

ISTRUZIONI DI MONTAGGIO - MOUNTING INSTRUCTIONS
 INSTRUCTIONS DE MONTAGE - BAUANLEITUNG - INSTRUCCIONES DE MONTAJE

①

SUPPORTO
 SUPPORT
 SUPPORT
 HALTERUNG
 SOPORTE
Q.TY n.1

②

SUPPORTO
 SUPPORT
 SUPPORT
 HALTERUNG
 SOPORTE
Q.TY n.2(Dx-Sx)

③

SUPPORTO
 SUPPORT
 SUPPORT
 HALTERUNG
 SOPORTE
Q.TY n.2(Dx-Sx)

④

SUPPORTO
 SUPPORT
 SUPPORT
 HALTERUNG
 SOPORTE
Q.TY n.2(Dx-Sx)

⑤

DISTANZIALE Ø24x14mm
 Foro Ø14mm, V620
 SPACER
 ENTRETOISE
 DISTANZBLECK
 DISTANCIADOR
Q.TY n.2

⑥

VITE TBEI M8x16mm
 SCREW M8x16mm
 VIS M8x16mm
 SCHRAUBE M8x16mm
 TORNILLO M8x16mm
Q.TY n.2

⑦

VITE TBEI M8x25mm
 SCREW M8x25mm
 VIS M8x25mm
 SCHRAUBE M8x25mm
 TORNILLO M8x25mm
Q.TY n.2

⑧

VITE TSCEI M6x16mm
 SCREW M6x16mm
 VIS M6x16mm
 SCHRAUBE M6x16mm
 TORNILLO M6x16mm
Q.TY n.2

⑨

VITE TCEI M6x35mm
 SCREW
 VIS
 SCHRAUBE
 TORNILLO
Q.TY n.4

⑩

VITE TCEI M8x35mm
 SCREW M8x35mm
 VIS M8x35mm
 SCHRAUBE M8x35mm
 TORNILLO M8x35mm
Q.TY n.1

⑪

VITE TE M6x16mm
 SCREW M6x16mm
 VIS M6x16mm
 SCHRAUBE M6x16mm
 TORNILLO M6x16mm
Q.TY n.2

⑫

RONDELLA Ø8x14mm
 WASHER Ø8x14mm
 RONDELLE Ø8x14mm
 SCHEIBE Ø8x14mm
 ARANDELA Ø8x14mm
Q.TY n.4

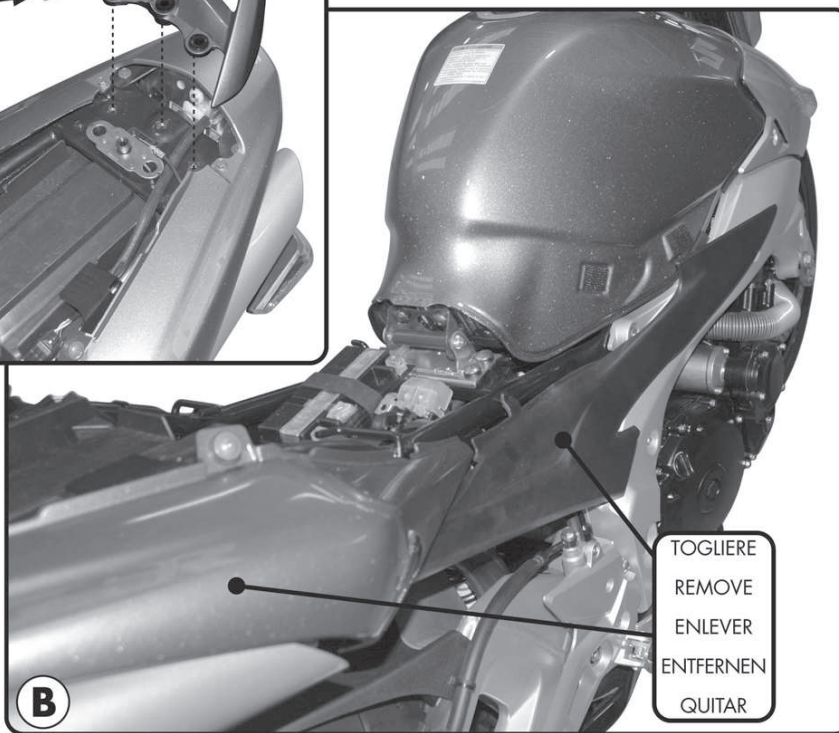
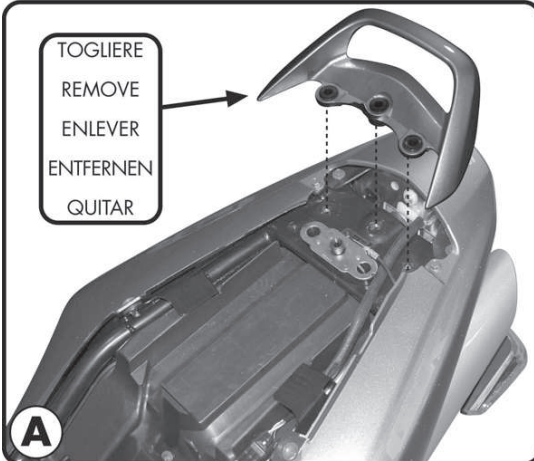

ATTENZIONE
 PESO SOSTENIBILE DAL
 PORTAPACCO 6Kg.

WARNING
 MAX. LOADING OF THE CARRIER
 6Kg. (13lbs)

ATTENTION
 CHARGE MAXIMALE 6Kg.

ACHTUNG
 MAXIMALE BELASTUNG DES
 TRÄGERS 6Kg.

¡ATENCIÓN!
 CARGA MÁXIMA AUTORIZADA 6Kg.

PORTAVALIGIA SPECIFICO - SPECIFIC CASE HOLDER
 PORTE-VALISE SPECIFIQUE - SPEZIFISCHER KOFFER-TRAGER
 PORTA-EQUIPAJE ESPECIFICO

SUZUKI GSR600 06/08

ISTRUZIONI DI MONTAGGIO - MOUNTING INSTRUCTIONS
 INSTRUCTIONS DE MONTAGE - BAUANLEITUNG - INSTRUCCIONES DE MONTAJE

13



RONDELLA Ø6mm
 WASHER Ø6mm
 RONDELLE Ø6mm
 SCHEIBE Ø6mm
 ARANDELA Ø6mm

Q.TY n.6

14



RONDELLA Ø6x20mm
 WASHER Ø6x20mm
 RONDELLE Ø6x20mm
 SCHEIBE Ø6x20mm
 ARANDELA Ø6x20mm

Q.TY n.4

15



RONDELLA Ø8mm
 WASHER Ø8mm
 RONDELLE Ø8mm
 SCHEIBE Ø8mm
 ARANDELA Ø8mm

Q.TY n.2

16



DADO A.B. M6
 BOLT M6
 ECROU M6
 MUTTER M6
 TUERCA M6

Q.TY n.4

17



DADO A.B. M8
 BOLT M8
 ECROU M8
 MUTTER M8
 TUERCA M8

Q.TY n.2

18



COPRIFORO
 BOLT CAP
 CACHE TROU
 STOPLOCK
 TAPA AGUJERO

Q.TY n.6

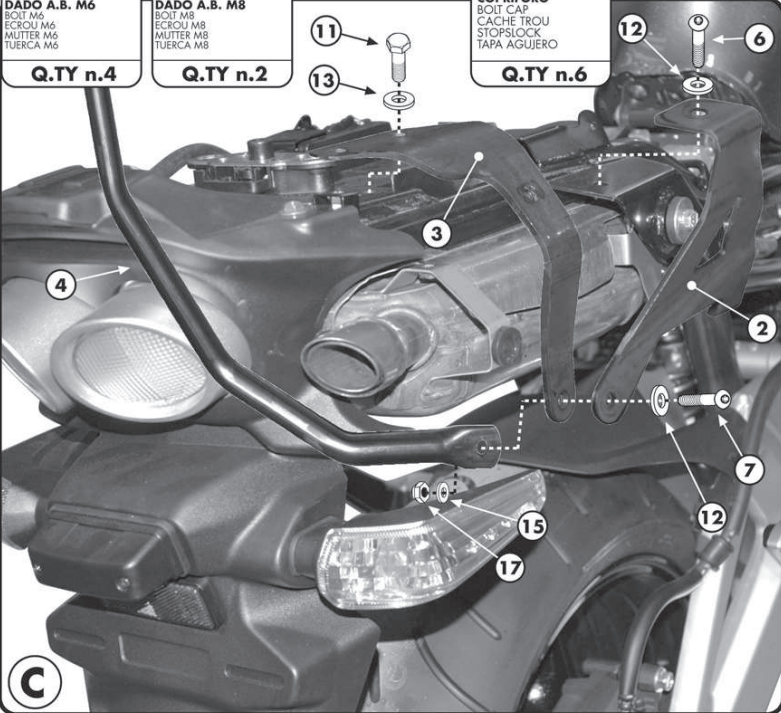

C

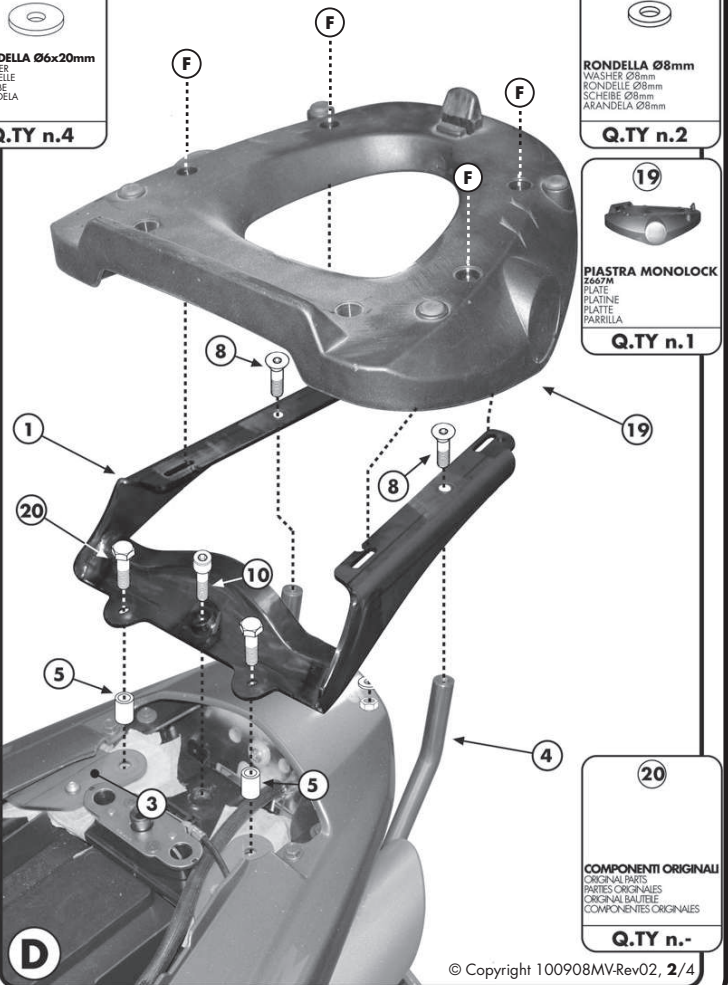

D



COMPONENTI ORIGINALI
 ORIGINAL PARTS
 PARTES ORIGINALES
 ORIGINAL BAUTEILE
 COMPONENTES ORIGINALES

Q.TY n.-

PORTAVALIGIA SPECIFICO - SPECIFIC CASE HOLDER
 PORTE-VALISE SPECIFIQUE - SPEZIFISCHER KOFFER-TRÄGER
 PORTA-EQUIPAJE ESPECIFICO

SUZUKI GSR 600 06/08

ISTRUZIONI DI MONTAGGIO - MOUNTING INSTRUCTIONS
 INSTRUCTIONS DE MONTAGE - BAUANLEITUNG - INSTRUCCIONES DE MONTAJE

- | | | |
|--|--|--|
| 21
 | 22
 | 23
 |
| GOMMINO
Z1822
RUBBER
CAOUTCHOUC
GUMMI
GOMA | RONDELLA IN GOMMA
Z1822
RUBBER WASHER
RONDELLE EN GOMME
GUMMISCHIBE
ARANDELA DE GOMA | DISTANZIALE Ø11x11mm
 foro Ø6,5mm
W67
SPACER
EINREIÖSE
DISTANZSTÜCK
DISTANCIADOR |
| Q.TY n.4 | Q.TY n.4 | Q.TY n. 4 |

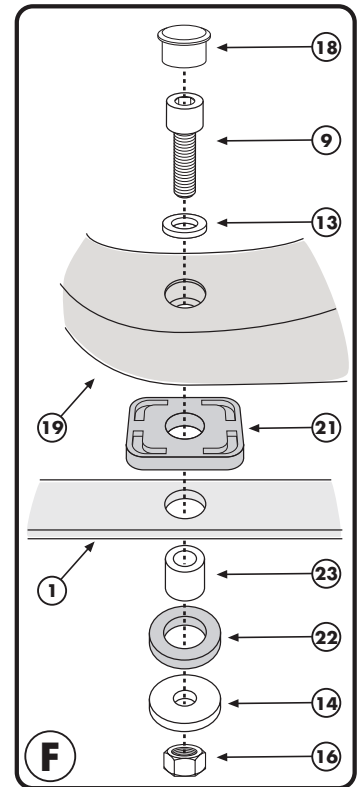

PORTAVALIGIA SPECIFICO - SPECIFIC CASE HOLDER
 PORTE-VALISE SPECIFIQUE - SPEZIFISCHER KOFFER-TRÄGER
 PORTA-EQUIPAJE ESPECIFICO

SUZUKI GSR600 06/08

ISTRUZIONI DI MONTAGGIO - MOUNTING INSTRUCTIONS
 INSTRUCTIONS DE MONTAGE - BAUANLEITUNG - INSTRUCCIONES DE MONTAJE

I ISTRUZIONI DI MONTAGGIO

1. SMONTARE IL MANIGLIONE ORIGINALE E LE PARTI DI CARENATURA INDICATE, FOTOGRAFIA A E B;
2. ESEGUIRE IL MONTAGGIO PROPOSTO IN FOTOGRAFIA C FACENDO ATTENZIONE ALLA CORRETTA SOVRAPPOSIZIONE DEI SUPPORTI N°2, N°3 E N°4;
3. RIMONTARE LE PARTI DI CARENATURA PRECEDENTEMENTE SMONTATE;
4. PROCEDERE AL MONTAGGIO DEI PARTICOLARI INDICATI IN FOTOGRAFIA D;
5. ULTIMARE IL MONTAGGIO CONTROLLANDO CHE TUTTE LE VITI SIANO SERRATE BENE.

GB MOUNTING INSTRUCTIONS

1. REMOVE THE ORIGINAL GRAB RAIL AND THE FAIRING PARTS AS INDICATED IN THE PICTURES A AND B;
2. PROCEED WITH THE MOUNTING STEPS AS INDICATED IN PICTURE C PAYING ATTENTION TO THE CORRECT OVERLAPPING OF THE SUPPORTS N°2, 3 AND 4;
3. REMOUNT THE PARTS OF THE FAIRING THAT YOU PREVIOUSLY REMOVED;
4. MOUNT THE PARTS INDICATED IN PICTURE D;
5. LASTLY CHECK THAT ALL SCREWS HAVE BEEN TIGHTENED.

F INSTRUCTIONS DE MONTAGE

1. DEMONTER LA POIGNEE D'ORIGINE ET LES PIECES DE CARROSSERIE INDIQUEES, PHOTOS A ET B ;
2. REALISER LE MONTAGE PROPOSE EN PHOTO C EN FAISANT ATTENTION A LA SUPERPOSITION CORRECTE DES SUPPORTS N°02, N°03 ET N°04 ;
3. REMONTER LES PIECES DE CARROSSERIE PRECEDEMENT DEMONTEES ;
4. PROCEDER AU MONTAGE DES PIECES INDIQUEES EN PHOTO D ;
5. TERMINER LE MONTAGE EN CONTROLANT LE BON SERRAGE DE TOUTES LES VIS.

D BAUANLEITUNG

1. ENTFERNEN SIE DEN ORIGINAL HANDGRIFF UND DIE TEILE DER VERKLEIDUNG WIE IN DEN BILDERN A UND B BESCHRIEBEN;
2. FÜHREN SIE DIE MONTAGE VOM BILD C DURCH UND BEACHTEN SIE DABEI, DASS DIE HALTERUNGEN NR. 2, 3 UND 4 KORREKT ÜBERLAGERT WERDEN;
3. MONTIEREN SIE DIE TEILE DER VERKLEIDUNG WIEDER AN, DIE SIE VORHER ABMONTIERT HATTEN;
4. MONTIEREN SIE DIE TEILE VOM BILD D;
5. ZULETZT ÜBERPRÜFEN SIE, DASS ALLE SCHRAUBEN FESTGEZOGEN WURDEN.

ES

INSTRUCCIONES DE MONTAJE

- 1) DESMONTAR EL ASA ORIGINAL DE LA MOTO Y LA PARTE DEL CARENADO, ILUSTRADO EN LA FOTOGRAFÍA CDA A Y B.
- 2) SEGUIR EL MONTAJE PROPUESTO EN LA FOTOGRAFÍA C, PRESTANDO ATENCIÓN EN LA CORRECTA SUPERPOSICIÓN DE LOS SOPORTES NUMERADOS 2, 3 Y 4 RESPECTIVAMENTE.
- 3) MONTAR LA PARTE DEL CARENADO QUE PREVIAMENTE HEMOS DESMONTADO;
- 4) PROCEDER AL MONTAJE DE LAS PIEZAS INDICADAS EN LA FOTOGRAFÍA D;
- 5) ULTIMAR EL MONTAJE, CONTROLANDO QUE TODAS LAS PIEZAS Y LOS TORNILLOS ESTEN BIEN APRETADOS.