

PORTAVALIGIE LATERALE SPECIFICO - SPECIFIC TUBULAR SIDE-CASE HOLDER
 PORTE-VALISES LATÉRAUX SPÉCIFIQUE - SPEZIFISCHES STAHLROHR-SEITENTRÄGER
 PORTA MALETAS LATERALES ESPECÍFICO

YAMAHA FZ1 1000

FAZER '06-'09

ISTRUZIONI DI MONTAGGIO - MOUNTING INSTRUCTIONS
 INSTRUCTIONS DE MONTAGE - BAUANLEITUNG - INSTRUCCIONES DE MONTAJE

①



SUPPORTO
 SUPPORT
 SUPPORT
 HALTERUNG
 SOPORTE

Q.TY n.2(Dx-Sx)

②



PONTE POSTERIORE
 REAR BRIDGE
 PONT POSTERIEURE
 VERBINDUNGSROHR
 PUENTE TRASERO

Q.TY n.1

③



VITE TEF M8x16mm
 SCREW
 VIS
 SCHRAUBE
 TORNILLO

Q.TY n.2

④



VITE TBEI M8x50mm
 SCREW
 VIS
 SCHRAUBE
 TORNILLO

Q.TY n.2

⑤



DADO A.B. M8
 FLANGIATO
 BOLT M8
 ECROU M8
 MÜTTER M8
 TUERCA M8

Q.TY n.4

⑥



RONDELLA Ø8x14mm
 WASHER Ø8x14mm
 RONDELLE Ø8x14mm
 SCHEIBE Ø8x14mm
 ARANDELA Ø8x14mm

Q.TY n.2

⑦



SUPPORTO
 SUPPORT
 SUPPORT
 HALTERUNG
 SOPORTE

Q.TY n.2 (Dx-Sx)

⑧



VITE TEF M8x25mm
 SCREW
 VIS
 SCHRAUBE
 TORNILLO

Q.TY n.2

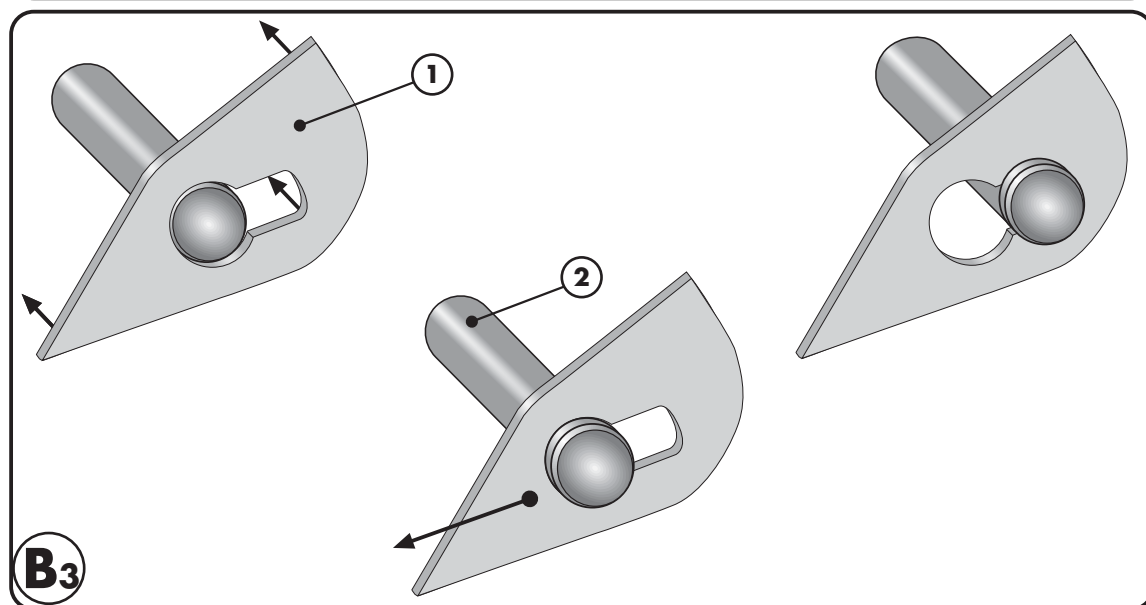
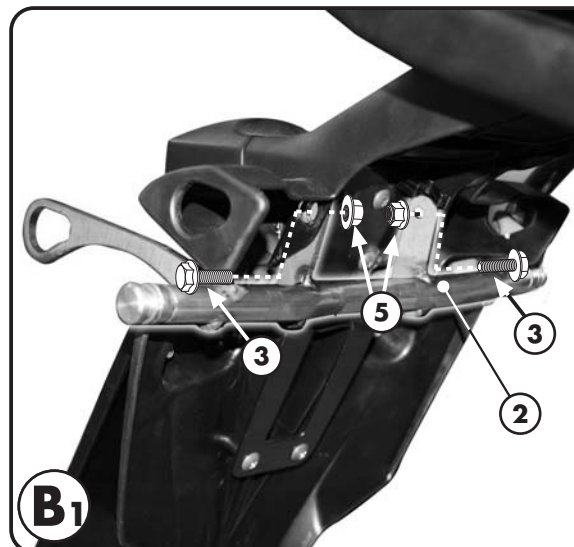
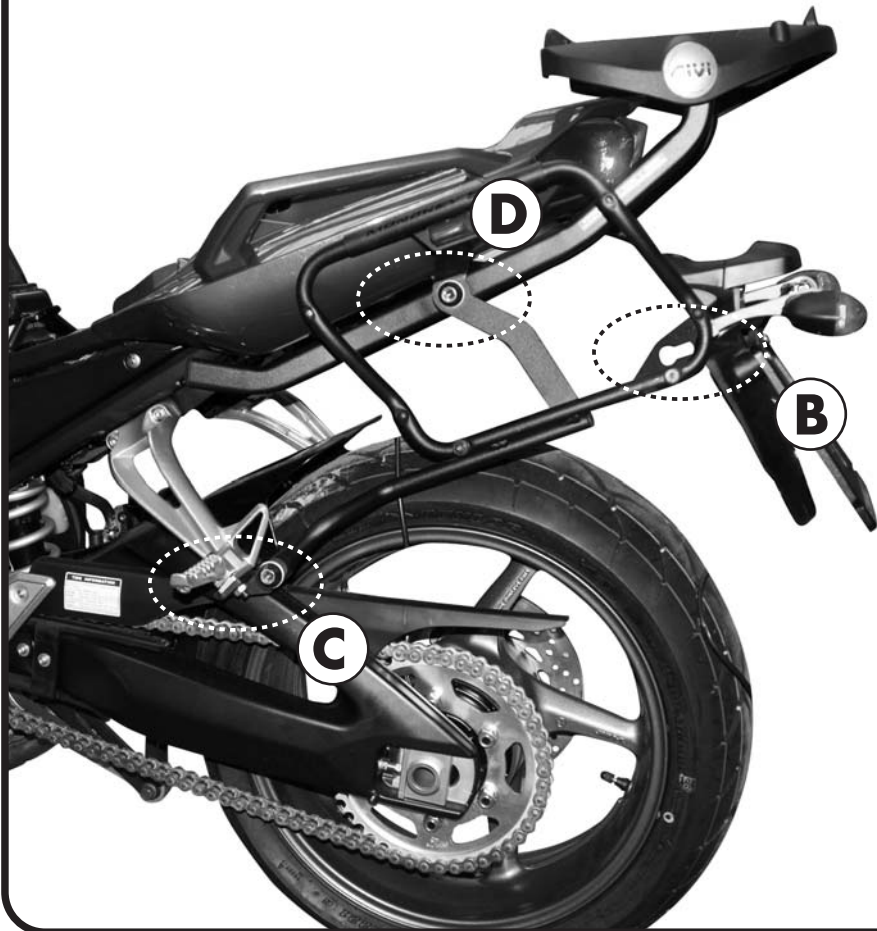

PORTAVALIGIE LATERALE SPECIFICO - SPECIFIC TUBULAR SIDE-CASE HOLDER
 PORTE-VALISES LATÉRAUX SPÉCIFIQUE - SPEZIFISCHES STAHLROHR-SEITENTRÄGER
 PORTA MALETAS LATERALES ESPECÍFICO

YAMAHA FZ1 1000 '09 FAZER

ISTRUZIONI DI MONTAGGIO - MOUNTING INSTRUCTIONS
 INSTRUCTIONS DE MONTAGE - BAUANLEITUNG - INSTRUCCIONES DE MONTAJE

9



BOCCOLA
 SCREW
 VIS
 SCHRAUBE
 TORNILLO

Q.TY n.2

10



DISTANZIALE Ø18x18mm
 Foro Ø8,5mm, rib int Ø 11x13,5
V498
 SPACER
 ENTRETOISE
 DISTANZSTÜCK
 DISTANCIADOR

Q.TY n.2

11

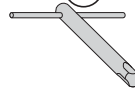

CHIAVE PER VITI A TESTA SPECIALE
 SPECIAL KEY
 CLE SPECIALE
 SPEZIALSCHLÜSSEL ZUR DEMONTAGE DES TRÄGERS
 LLAVE PARA TORNILLOS CON CABEZA ESPECIAL

Q.TY n.1

12

PARTICOLARI INCLUSI NEL KIT AGGIUNTIVO
 COMPONENTS INCLUDED IN THE ADDITIONAL FITTING KIT
 PIÈCES INCLUES DANS LE KIT DE VIS ADDITIONNEL
 DIE EINZELNEN TEILE SIND BEI ZUSÄTZLICHEM MONTAGEKIT ENTHALTEN
 DESPIECES INCLUIDOS EN EL KIT DE ANCLAJES DEL PORTA MALETAS ANADIDOS

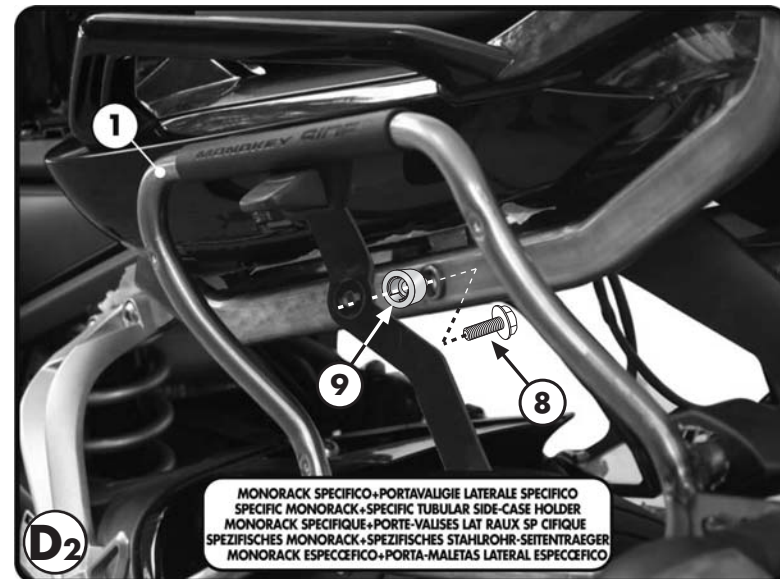
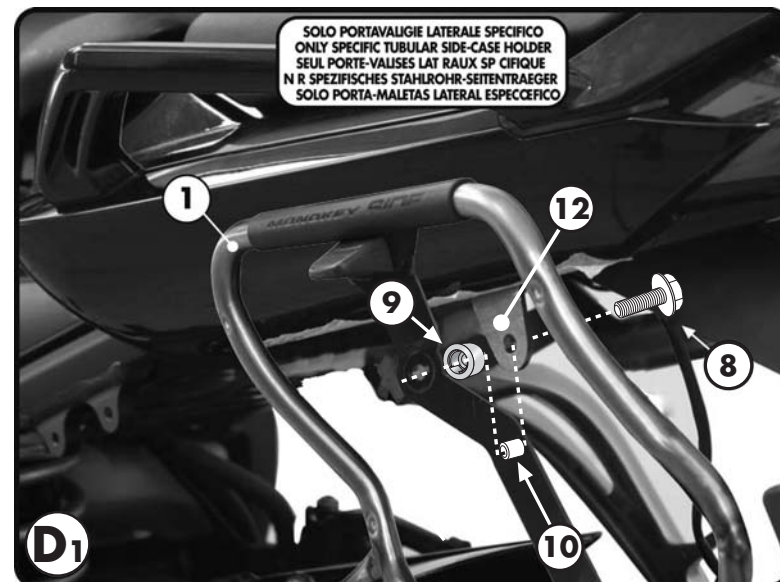
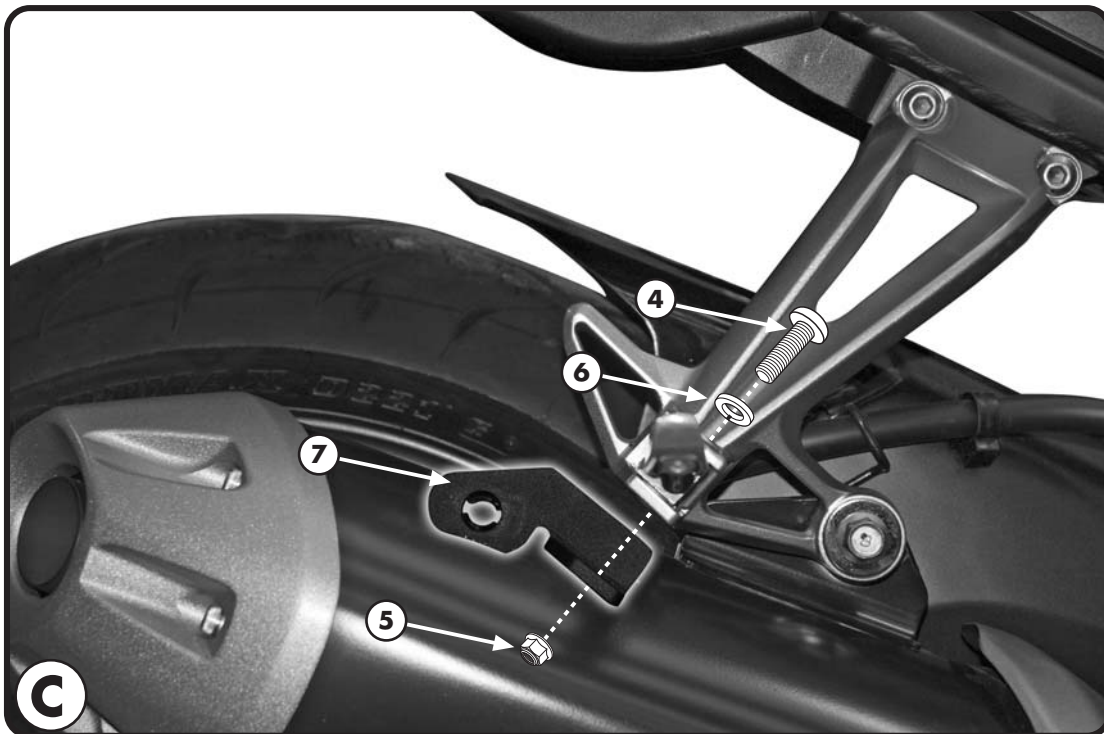

MONTAGGIO / SMONTAGGIO PORTAVALIGE LATERALE VERSIONE PLXR "RAPID"



I

1. INSERIRE L'ATTREZZO NELLA TESTA DELLA VITE SPECIALE;
2. RUOTARE DI 1/4 DI GIRO IN SENSO ORARIO FINO A CHÉ LA ROTAZIONE NON TERMINA E SI AVVERTE LO SCATTO;
3. PER SMONTARE PROCEDERE IN SENSNO INVERSO.

GB

1. INSERT THE SPECIAL KEY INTO THE HEAD OF THE SCREW;
2. TURN THE KEY ¼ TURN CLOCKWISE UNTIL ROTATION STOPS AND THE SIDE CASE HOLDER IS FASTENED SECURELY TO THE FITMENT POINT;
3. IN ORDER TO DISASSEMBLE THE BRACKETRY PERFORM THE OPERATION IN REVERSE.

F

1. INSERER LA CLE SPECIALE DANS LA TETE DE LA VIS;
2. VISSER D'1/4 DE TOUR DANS LE SENS HORAIRE JUSQU'AU BLOCAGE DE LA VIS POUR MONTER EN TOUTE SECURITE LE SUPPORT A SON POINT DE FIXATION;
3. POUR LE DEMONTAGE, PROCEDER EN SENSE INVERSE.

D

1. STECKEN SIE DAS WERKZEUG IN DEN KOPF DER SPEZIFISCHEN SCHRAUBE;
2. DREHEN SIE DIE SCHRAUBE 1 / 4 UMDREHUNG IM UHRZEIGERSINN BIS SIE BEMERKEN, DASS DIE SCHRAUBE IM BEFESTIGUNGSPUNKT EINGEKLEMMT IST;
3. FÜR DIE DEMONTAGE FOLGEN SIE DEN HINWEISE UMGEKEHRT.

ES

1. INSERTAR LA LLAVE ESPECIAL EN LA CABEZA DEL TORNILLO
2. DAR ¼ DE VUELTA EN EL SENTIDO HORARIO HASTA QUE LLEGUE AL TOPE Y SE VEA EL TORNILLO;
3. PARA DESMONTARLO PROCEDER EN LA DIRECCIÓN CONTRARIA;

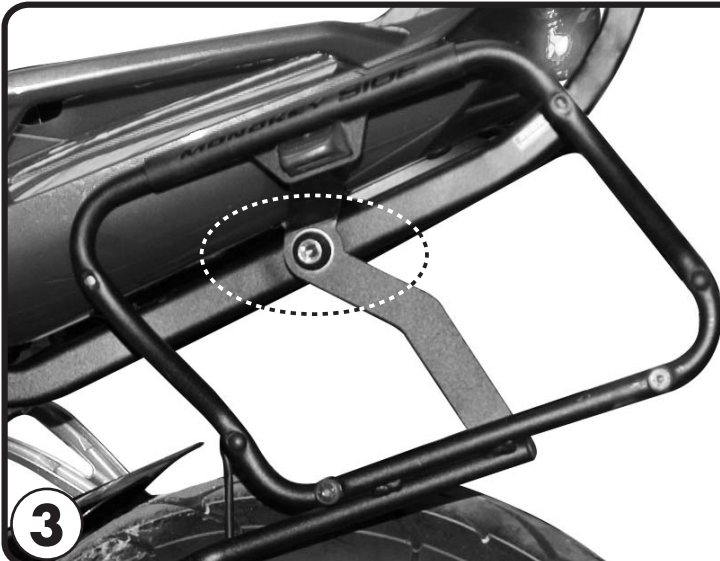

VITE NASCOSTA

LA VITE NASCOSTA IMPEDISCE LO SMONTAGGIO DEL PLXR QUANDO LA VALIGIA E' MONTATA

HIDDEN SCREW

THE HIDDEN SCREW DOES NOT ALLOW THE PLXR TO BE REMOVED WHEN THE CASE IS MOUNTED

VIS CACHEE

LA VIS CACHEE EMPECHE LE DEMONTAGE DU PLXR QUAND LA VALISE EST MONTÉE.

DIE SCHRAUBE IST VERSTECKT

DIE VERSTECKTE SCHRAUBE ERMÖGLICHT KEINE DEMONTAGE DES PLXR WENN DER KOFFER MONTIERT IST.

TORNILLO OCULTO

EL TORNILLO OCULTO IMPIDE PODER DESMONTAR EL PLXR CUANDO LA MALETA ESTÀ MONTADA.

PORTAVALIGIE LATERALE SPECIFICO - SPECIFIC TUBULAR SIDE-CASE HOLDER
 PORTE-VALISES LATÉRAUX SPÉCIFIQUE - SPEZIFISCHES STAHLROHR-SEITENTRAEGER
 PORTA MALETAS LATERALES ESPECÍFICO

YAMAHA FZ1 1000 '09

FAZER

ISTRUZIONI DI MONTAGGIO - MOUNTING INSTRUCTIONS
 INSTRUCTIONS DE MONTAGE - BAUANLEITUNG - INSTRUCCIONES DE MONTAJE

I ISTRUZIONI DI MONTAGGIO

1. SMONTARE LE FRECCHE DALLA LORO POSIZIONE ORIGINALE E FISSARLE AL PONTE;
2. FISSARE IL PONTE POSTERIORE COME INDICATO IN FIGURA B1;
3. FISSARE IL SUPPORTO NUMERO 7 COME INDICATO IN FIGURA C;
4. AGGANCIARE IL PLXR NEI PUNTI B e C;
5. ULTIMARE IL MONTAGGIO SEGUENDO LE FIGURE D1 o D2, CHE MOSTRANO L'UTILIZZO DEL PLXR IN PRESENZA E IN ASSENZA DEL MONORACK.
6. VERIFICARE CHE TUTTE LE VITI SIANO SERRATE BENE (VITI M6=9,6Nm - VITI M8=23Nm).

GB MOUNTING INSTRUCTIONS

1. REMOVE THE REAR DIRECTIONAL LIGHTS FROM THEIR ORIGINAL POSITION;
2. INSTALL THE BRIDGE AS YOU CAN SEE FROM PICTURE B1 AND THEN INSTALL THE REAR DIRECTIONAL LIGHTS IN THEIR NEW LOCATION SHOWN IN PICTURE B2;
3. INSTALL THE SUPPORT BRACKET, ITEM N°7, AS SHOWN IN PICTURE C;
4. ATTACH THE PLXR AT POINTS B AND C USING METHOD DESCRIBED IN FIGURE B3 (ALL ON PAGE 1);
5. COMPLETE THE INSTALLATION FOLLOWING PICTURES D1 AND D2, WHICH SHOW THE USE OF PLXR WITH OR WITHOUT THE MONORACK ARMS;
6. MAKE SURE THAT ALL THE NUTS AND BOLTS ARE TIGHTENED APPROPRIATELY (BOLTS M6=9.6Nm - BOLTS M8=23Nm).

F INSTRUCTIONS DE MONTAGE

1. DEMONTER LES CLIGNOTANTS DE LEUR POSITION ORIGINALE ET LES FIXER A LA PIECE N°2;
2. FIXER LA PIECE N°2 COMME INDIQUE EN PHOTO B1;
3. FIXER LES SUPPORT N°7 COMME INDIQUE EN PHOTO C;
4. ACCROCHER LE PLXR AUX POINTS B ET C;
5. TERMINER LE MONTAGE EN SUIVANT LES PHOTOS D1 ET D2, QUI ILLUSTRENT L'USAGE DU PLXR EN PRESENCE ET EN ABSENCE DU MONORACK;
6. CONTROLER LE BON SERRAGE DE TOUTES LES VIS (VIS M6=9,6Nm - VIS m8=23Nm).

D BAUANLEITUNG

1. ENTFERNEN SIE DIE BÜNKER VON DER ORIGINALPOSITION UND BEFESTIGEN SIE DIESE AN DER BRÜCKE;
2. BEFESTIGEN SIE DIE HINTERE BRÜCKE WIE IM BILD B1 GEZEIGT;
3. BEFESTIGEN SIE DIE HALTERUNG NR. 7 WIE IM BILD C GEZEIGT;
4. BEFESTIGEN SIE DEN PLXR AN DEN PUNKTEN B UND C;
5. BEENDEN SIE DIE MONTAGE WIE IN DEN BILDERN D1 ODER D2 GEZEIGT, DIE DIE BENUTZUNG DES PLXR MIT ODER OHNE MONORACK ZEIGEN;
6. ÜBERPRÜFEN SIE DASS ALLE SCHRAUBEN (SCHRAUBEN M6=9,6NM - SCHRAUBEN M8=23NM) FESTGEZOGEN WURDEN.

ES INSTRUCCIONES DE MONTAJE

1. DESMONTAR LOS INTERMITENTES DE LA POSICIÓN ORIGINAL Y VOLVER A MONTARLOS EN EL PUENTE TRASERO;
2. FIJAR EL PUENTE TRASERO COMO SE MUESTRA EN LA ILUSTRACIÓN B1;
3. FIJAR EL SOPORTE NÚMERO 7 COMO SE INDICA EN LA ILUSTRACIÓN C;
4. COLOCAR EL PLXR A LOS PUNTOS B Y C;
5. COMPLETAR EL MONTAJE SIGUIENDO LAS ILUSTRACIONES D1 Y D2, QUE MUESTRAN COMO USAR EL PLXR EN PRESENCIA O EN AUSENCIA DEL MONORACK.
6. VERIFICAR QUE TODOS LOS TORNILLOS ESTEN BIEN APRETADOS (TORNILLOS M6=9,6NM - TORNILLOS M8=23NM).