

PIASTRA SPECIFICA - SPECIFIC PLATE  
 PLATINE SPECIFIQUE - SPEZIFISCHE PLATTE - PARRILLA ESPECÍFICA

# SUZUKI AN400 2006 BURGMAN

ISTRUZIONI DI MONTAGGIO - MOUNTING INSTRUCTIONS  
 INSTRUCTIONS DE MONTAGE - BAUANLEITUNG - INSTRUCCIONES DE MONTAJE

**1**



**SUPPORTO**  
 SUPPORT  
 SUPPORT  
 HALTERUNG  
 SOPORTE

**Q.TY n.1**

**2**



**VITE TBEI M8x45mm**  
 Nero  
 SCREW M8x45mm  
 VIS M8x45mm  
 SCHRAUBE M8x45mm  
 TORNILLO M8x45mm

**Q.TY n.4**

**3**



**RONDELLA Ø8x14mm**  
 Nero  
 WASHER Ø8x14mm  
 RONDELLE Ø8x14mm  
 SCHEIBE Ø8x14mm  
 ARANDELA Ø8x14mm

**Q.TY n.4**

**4**



**DISTANZIALE Ø18x25mm**  
 Foro Ø8,5mm, V632  
 SPACER  
 ENTRETÈISE  
 DISTANZSTÜCK  
 DISTANCIADOR

**Q.TY n.2**

**5**



**DISTANZIALE Ø18x20mm**  
 Foro Ø8,5mm, V559  
 SPACER  
 ENTRETÈISE  
 DISTANZSTÜCK  
 DISTANCIADOR

**Q.TY n.2**

**6**



**PIASTRA MONOKEY**  
 Z622M  
 PLATE  
 PLATINE  
 PLATTE  
 PARRILLA

**Q.TY n.1**

**7**



**COPRIFORO**  
 Z621  
 BOLT CAP  
 CACHE TROU  
 STOPSLOCK  
 TAPA AGUJERO

**Q.TY n.6**

**8**



**VITE TCEI M6x35mm**  
 SCREW  
 VIS  
 SCHRAUBE  
 TORNILLO

**Q.TY n.4**

**9**



**RONDELLA f6x20mm**  
 WASHER  
 RONDELLE  
 SCHEIBE  
 ARANDELA

**Q.TY n.4**

**10**



**DADO A.B. M6**  
 BOLT M6  
 ÉCROU M6  
 MUTTER M6  
 TUERCA M6

**Q.TY n.4**

**11**



**RONDELLA MOUSSE**  
 Z1072  
 WASHER  
 RONDELLE  
 SCHEIBE  
 ARANDELA

**Q.TY n.4**

**12**



**RONDELLA Ø6mm**  
 WASHER Ø6mm  
 RONDELLE Ø6mm  
 SCHEIBE Ø6mm  
 ARANDELA Ø6mm

**Q.TY n.4**

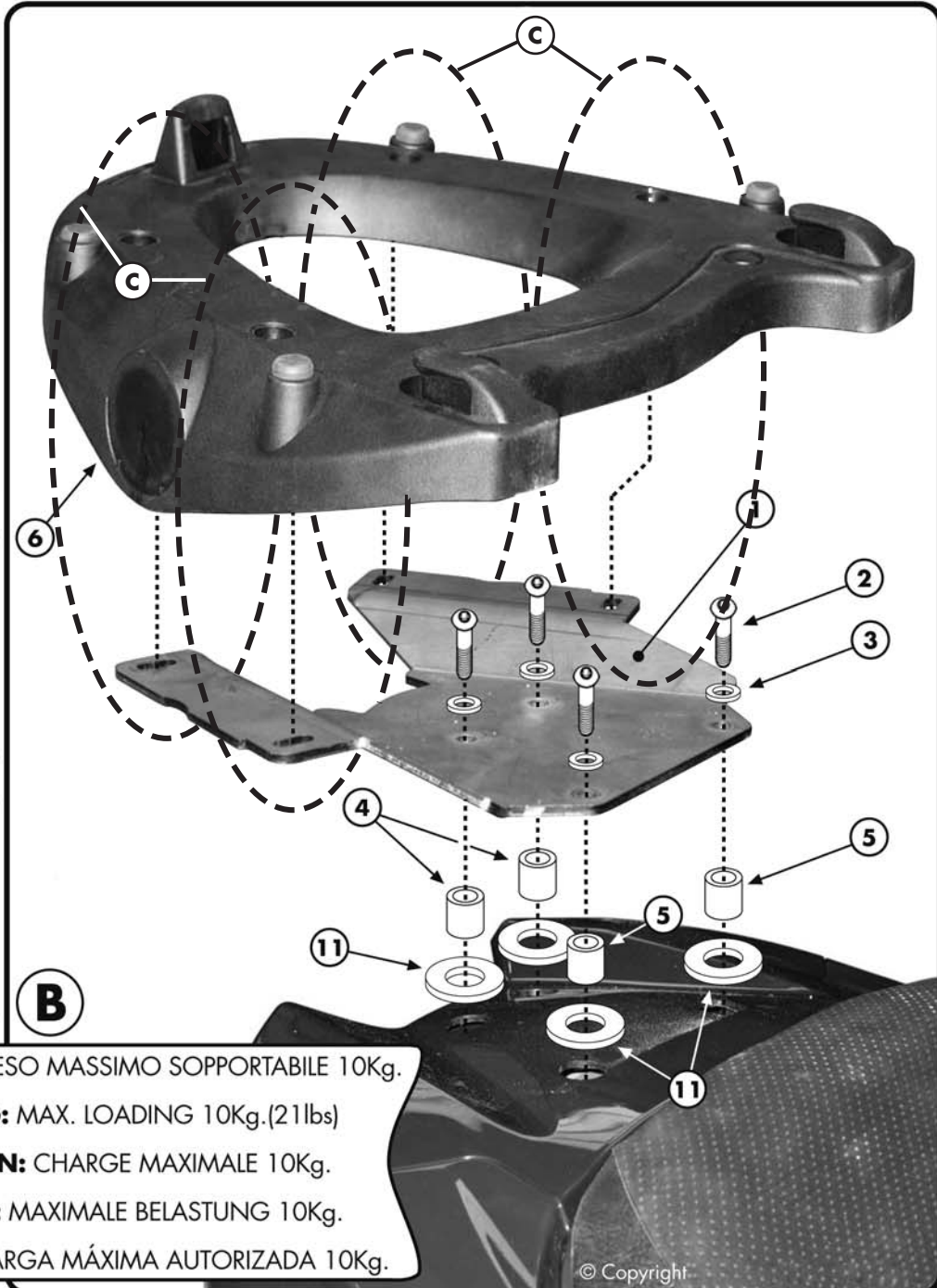

**ATTENZIONE:** PESO MASSIMO SOPPORTABILE 10Kg.  
**WARNING:** MAX. LOADING 10Kg.(21lbs)  
**ATTENTION:** CHARGE MAXIMALE 10Kg.  
**ACHTUNG:** MAXIMALE BELASTUNG 10Kg.  
**¡ATENCIÓN!** CARGA MÁXIMA AUTORIZADA 10Kg.

PIASTRA SPECIFICA - SPECIFIC PLATE  
PLATINE SPECIFIQUE - SPEZIFISCHE PLATTE - PARRILLA ESPECÍFICA

# SUZUKI AN400 2006 BURGMAN

ISTRUZIONI DI MONTAGGIO - MOUNTING INSTRUCTIONS  
INSTRUCTIONS DE MONTAGE - BAUANLEITUNG - INSTRUCCIONES DE MONTAJE

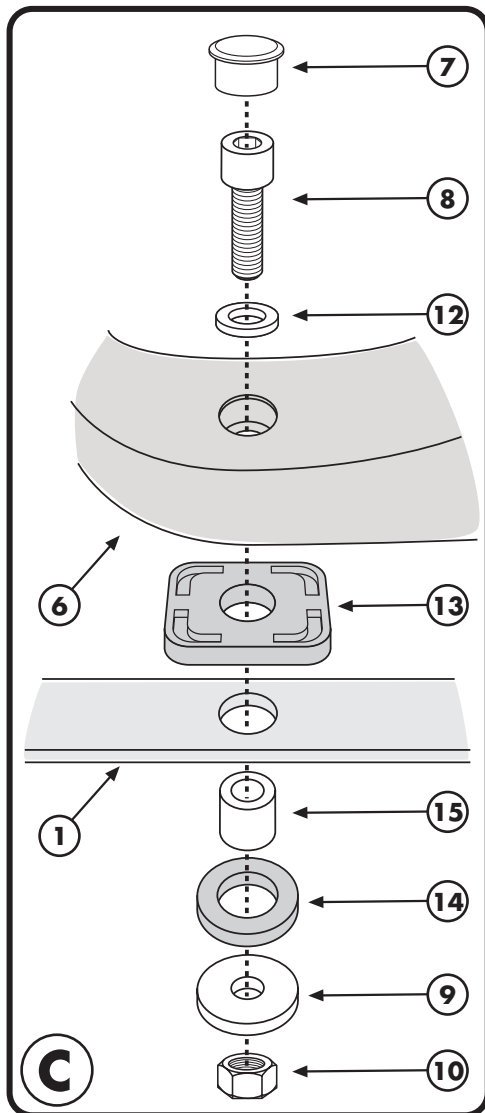

**13**

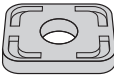

**GOMMINO**  
Z1822  
RUBBER  
CAOUTCHOUC  
GUMMI  
GOMA

**Q.TY n.4**

**14**



**RONDELLA IN GOMMA**  
Z1823  
RUBBER WASHER  
RONDELLE EN GOMME  
GUMMISCHEIBE  
ARANDELA DE GOMA

**Q.TY n.4**

**15**



**DISTANZIALE f11x11mm**  
foro f6,5mm  
V687  
SPACER  
ENTRETÔISE  
DISTANZSTÜCK  
DISTANCIADOR

**Q.TY n. 4**

PIASTRA SPECIFICA - SPECIFIC PLATE  
 PLATINE SPECIFIQUE - SPEZIFISCHE PLATTE - PARRILLA ESPECÍFICA

**SUZUKI AN400 2006**  
**BURGMAN**

ISTRUZIONI DI MONTAGGIO - MOUNTING INSTRUCTIONS  
 INSTRUCTIONS DE MONTAGE - BAUANLEITUNG - INSTRUCCIONES DE MONTAJE

## I ISTRUZIONI DI MONTAGGIO

1. SMONTARE LA CARTER DI PLASTICA DI CHIUSURA DEL MANIGLIONE ORIGINALE E FORARLO NEI PUNTI INDICATI, FOTOGRAFIA A, FINO A RAGGIUNGERE UN DIAMETRO MASSIMO DEL FORO DI 18,5mm;
2. RIMONTARE IL CARTER NELLA SUA POSIZIONE ORIGINALE;
3. PROSEGUIRE NEEL MONTAGGIO COME INDICATO IN FOTOGRAFIA B;
4. ULTIMARE IL MONTAGGIO CONTROLLANDO CHE TUTTE LE VITI SIANO SERRATE BENE.

## GB MOUNTING INSTRUCTIONS

1. REMOVE THE PLASTIC COVER OF THE ORIGINAL CARRIER; DRILL IT IN THE INDICATED POINTS TO A DIAMETER OF 18,5mm (PICTURE A);
2. REMOUNT THE PLASTIC COVER IN ITS ORIGINAL POSITION;
3. PROCEED WITH THE MOUNTING AS SHOWN IN PICTURE B;
4. LASTLY CHECK THAT ALL SCREWS HAVE BEEN TIGHTENED

## F INSTRUCTIONS DE MONTAGE

1. DEMONTER LE CACHE PLASTIQUE DE LA POIGNEE PASSA D'ORIGINE ET LA PERCER AUX POINTS INDIQUEES (PHOTO A) JUSQU'A OBTENIR UN DIAMETRE MAXIMUM DE 18,5mm;
2. REMONTER LE CACHE DANS SA POSITION INITIALE ;
3. POURSUIVRE LE MONTAGE COMME INDIQUE EN PHOTO B;
4. TERMINER LE MONTAGE EN CONTROLANT LE BON SERRAGE DE TOUTES LES VIS.

## D BAUANLEITUNG

1. ENTFERNEN SIE DIE PLASTIK ABDECKUNG DES ORIGINAL TRÄGERS; BOHREN SIE EIN LOCH IN DIE ANGEgebenEN PUNKTE BIS ZU EINEM DURCHMESSER VON 18,5mm (BILD A);
2. MONTIEREN SIE DIE PLASTIKABDECKUNG IN SEINER ORIGINALSTELLE;
3. GEHEN SIE MIT DER MONTAGE WEITER WIE IM BILD B BESCHRIEBEN;
4. ZULETZT ÜBERPRÜFEN SIE, DASS ALLE SCHRAUBEN FESTGEZOGEN WURDEN.

## ES

## INSTRUCCIONES DE MONTAJE

1. DESMONTAR LA TAPA DE PLÁSTICO DEL ASA ORIGINAL, TALADRARLA EN LOS PUNTOS INDICADOS HASTA OBTENER UN DIÁMETRO MÁXIMO DE 18,5mm (VER FOTO A);
2. MONTAR LA TAPA DE PLÁSTICO EN SU POSICIÓN ORIGINAL;
3. PROCEDER AL MONTAJE COMO INDICA LA FOTO B;
4. FINALIZAR EL MONTAJE ASEGURÁNDOSE DE QUE TODOS LOS TORNILLOS ESTÉN BIEN APRETADOS.