

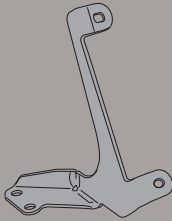









A2113A- A2113A

ATTACCHI SPECIFICI PER - SPECIFIC FITTING KIT FOR - KIT DE MONTAGE SPECIFIQUE POUR
 SPEZIFISCHER MONTAGEKIT FÜR - ANCLAJE ESPECÍFICO PARA - ANCORADOURO ESPECÍFICO

YAMAHA AEROX R 50 (2013)

N°	Descrizione	Caratteristiche	Codice	Quantità	
1	Supporto - Support - Support Halterung - Soporte - Apoio	Sp. 3mm	GN2474	2 (Dx;Sx)	
2	Vite - Screw Vis - Schraube Tornillo - Parafuso	TBEI M6x25	625TBEI	4	
3	Vite - Screw Vis - Schraube Tornillo - Parafuso	TCEI M8x20	820TCE	1	
4	Vite - Screw Vis - Schraube Tornillo - Parafuso	TCEI M8x20 Passo Sx	850TECS	1	
5	Rondella - Washer Rondelle - Scheibe Arandela - Arruela	Ø8x14	814RON	2	
6	Rondella - Washer Rondelle - Scheibe Arandela - Arruela	Ø8x14	814RONZ	2	
7	Dado - Bolt - Ecrou Mutter - Tuerca - Porca	Dado Auto Bloccante Flangiato M6	6DADIAFLN	4	
8	Dado - Bolt - Ecrou Mutter - Tuerca - Porca	Dado M8 Passo Sx	8DADIES	1	
9	Dado - Bolt - Ecrou Mutter - Tuerca - Porca	Dado M8	8DADI	1	
10	Boccola Di Ritenzione - Plastic Bush Douille Plastique - Plastik Buchse Casquillo - Concha	-	Z871N	4	
11	Gommino - Fairleader Chaumard - Gummi Goma- Borracha	-	Z268	4	
12	-	-	-	-	

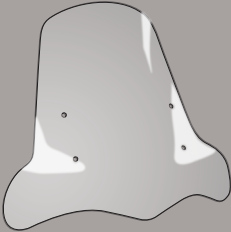
A2113A- A2113A

ATTACCHI SPECIFICI PER - SPECIFIC FITTING KIT FOR - KIT DE MONTAGE SPECIFIQUE POUR
SPEZIFISCHER MONTAGEKIT FÜR - ANCLAJE ESPECÍFICO PARA - ANCORADOURO ESPECÍFICO

YAMAHA AEROX R 50 (2013)

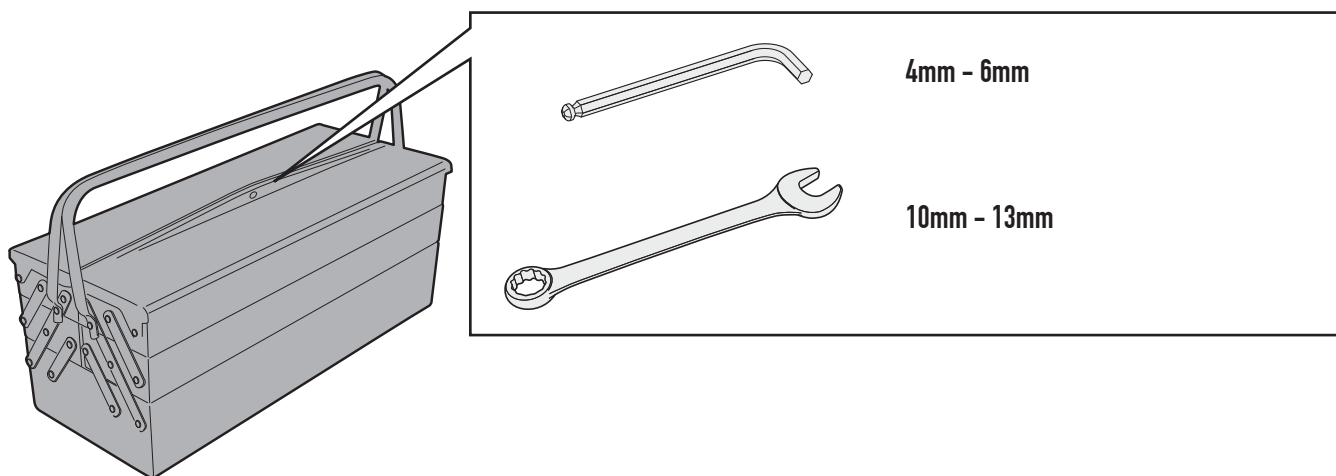

A2113A- A2113A

ATTACCHI SPECIFICI PER - SPECIFIC FITTING KIT FOR - KIT DE MONTAGE SPECIFIQUE POUR
SPEZIFISCHER MONTAGEKIT FÜR - ANCLAJE ESPECÍFICO PARA - ANCORADOURO ESPECÍFICO

YAMAHA AEROX R 50 (2013)

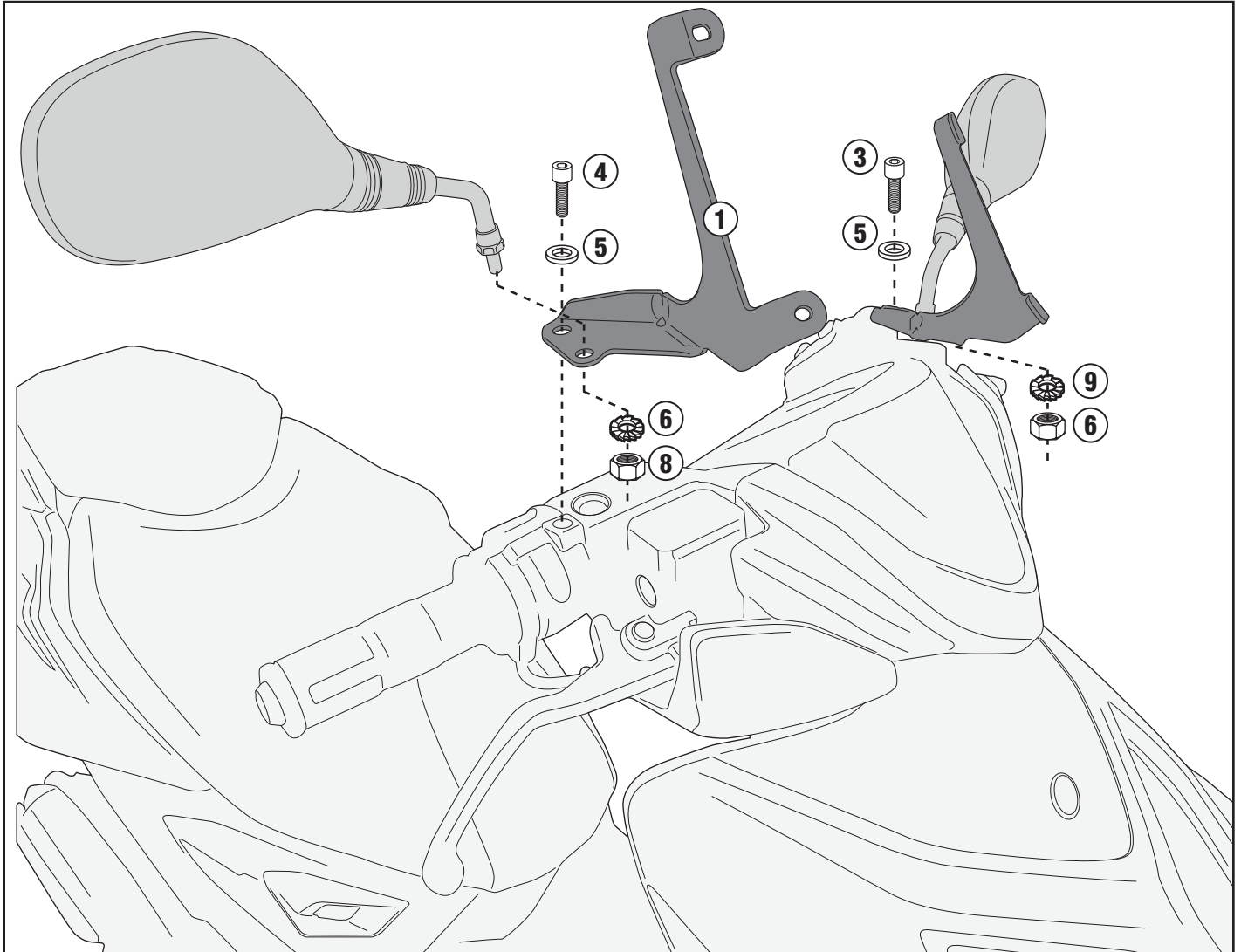

A2113A- A2113A

ATTACCHI SPECIFICI PER - SPECIFIC FITTING KIT FOR - KIT DE MONTAGE SPECIFIQUE POUR
SPEZIFISCHER MONTAGEKIT FÜR - ANCLAJE ESPECÍFICO PARA - ANCORADOURO ESPECÍFICO

YAMAHA AEROX R 50 (2013)

