



MODEL
 HONDA INTEGRA 700 2012
 HONDA INTEGRA 750 2014
 HONDA NC 700 S/X 2012
 HONDA NC 750 S/X 2014

LINE SPORT

MUFFLER SPEED EDGE

SCHEMATIC

ELENCO PARTI / PARTS LIST

#	QTÀ / QTY	DESCRIZIONE / DESCRIPTION	CODICE / CODE
1	1	Vite M5 x 8 / Screw M5 x 8	50.73.459.1
2	1	DB killer / DB killer	50.DK.088.0
3	1	Tappo in gomma / Rubber stopper	50.73.266.1
4	1	Silenziatore / Muffler	SPEED EDGE 350
5	1	Staffa in carbonio / Carbon fiber bracket	50.SS.814.1
6	1	Vite M8x40 / Screw M8x40	50.73.075.1
7	1	Vite M8x50 / Screw M8x50	50.73.074.1
8	2	Rondella in alluminio nera / Black aluminium washer	50.73.221.1
9	1	Bussola in alluminio / Aluminium bush (Ø30/23.6 - NC700)	50.73.353.1
10	2	Silentblock / Silentblock	50.73.380.1
11	2	Boccola / Bush	50.73.381.1
12	1	Staffa / Bracket	50.SS.683.0
13	2	Dado M8 flangiato / Flanged nut M8	50.73.393.1
14	1	Gommino paracolpi / Rubber buffer	50.72.010.1
15	1	Bussola in alluminio / Aluminium bush (Ø28/23 - INTEGRA)	50.73.264.1
16	1	Tubo di raccordo / Link pipe	9773H046SHX
17	1	Fascetta Ø 40/43 mm / Pipe clamp Ø 40/43 mm	50.FA.005.1
18	2	Dado rapido / Cage nut	50.66.009.1
19	1	Copertura in alluminio / Aluminium cover	50.CR.012.1
20	2	Vite M6 x 12 / Screw M6 x 12	50.72.024.1
21	2	Molla media / Middle spring	50.73.359.1
22	2	Tubo in gomma per molla / Rubber pipe for spring	50.73.210.1

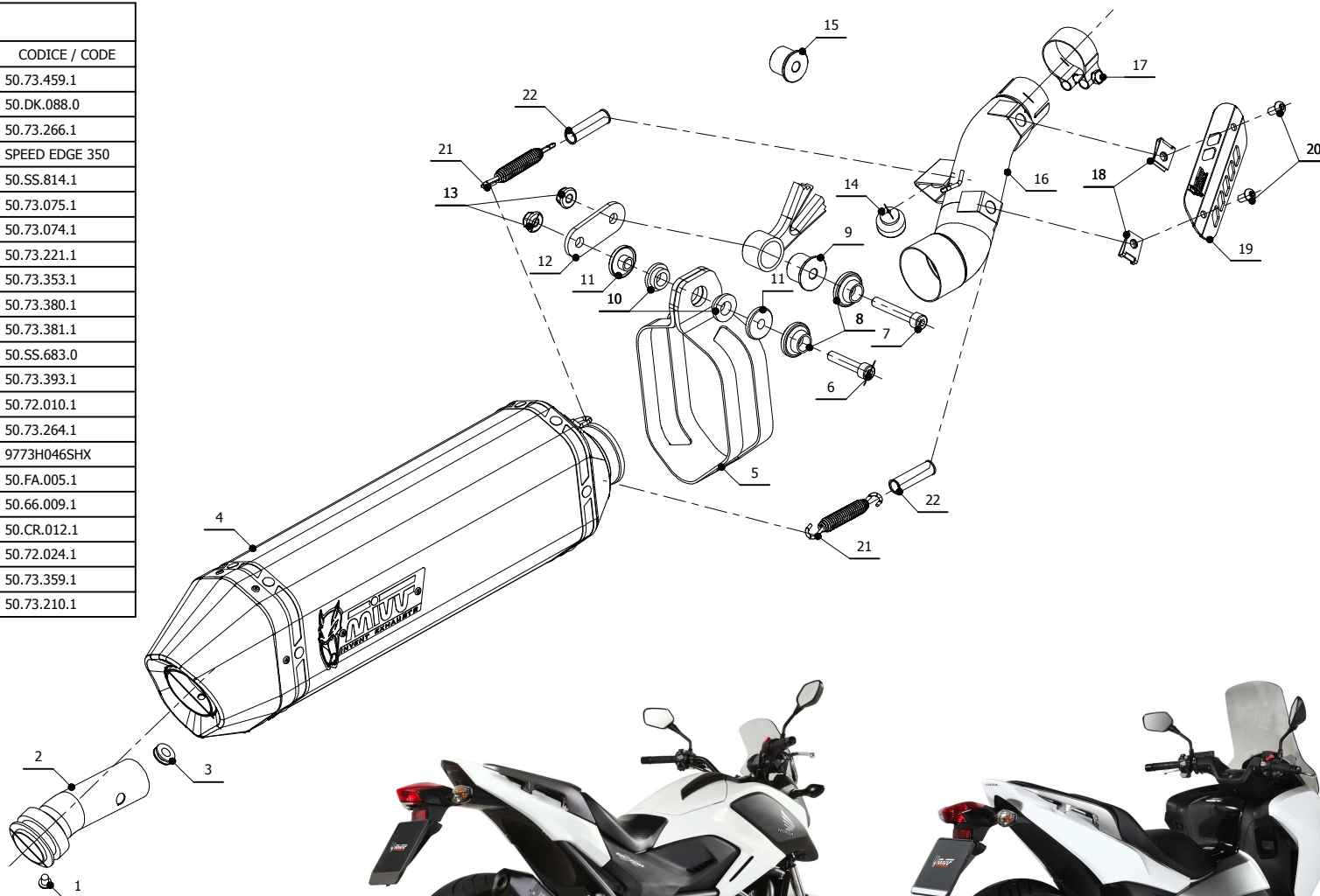

APPLICAZIONI / APPLICATIONS

CODICE / CODE	TUBO / PIPE	SILENZIATORE / MUFFLER	FASCETTA / CLAMP	CODICE OMOL. / HOMOL. CODE
H.046.LRX	INOX / ST. STEEL	INOX (COPPE CARBONIO) / ST. STEEL (CARBON CAPS)	CARBONIO / CARBON FIBER	ME008 e9 1176
H.046.LRB	INOX / ST. STEEL	STEEL BLACK	CARBONIO / CARBON FIBER	ME008 e9 1176