

## HONDA XL650 Transalp

### Schutzbügel Montagehinweise

Alle vom Motorrad gelösten Schrauben sind gemäß Herstellerangaben wieder zu montieren, oder mit von SW-MOTECH gelieferten Schrauben zu ersetzen. Falls nicht anderweitig definiert, diese Schrauben nach Tabelle anziehen.

M6	9,6 Nm
M8	23 Nm
M10	46 Nm

Gegebenenfalls Schrauben mit flüssiger Schraubensicherung einkleben.

Prüfen Sie nach 50 km alle Verbindungen auf festen Sitz.

M6	9,6 Nm
M8	23 Nm
M10	46 Nm

All screws, bolts and nuts should be checked after driving the first 50 km to ensure that all are tightened to the proper torque.

Medium strength liquid thread-locker (i.e., "Locktite") should be used to secure all screws, bolts and nuts.

SW-MOTECH GmbH & Co. KG  
Ernteweg 8/10  
35282 Rauschenberg  
-Germany-

Tel.: ++ 49 (0) 6425 816 800  
Fax: ++ 49 (0) 6425 816 810

www.sw-motech.com

### Crash Bar Mounting Instructions

SW-MOTECH products should be installed by a qualified, experienced motorcycle technician. If you are unsure of your ability to properly install a product, please have the product installed by your local motorcycle dealer. SW-MOTECH takes no responsibility for damages caused by improper installation.

All screws, bolts and nuts, including all replacement hardware provided by SW-MOTECH, should be tightened to the torque specified in the OEM maintenance manual for your motorcycle. If no torque specifications are provided in the OEM maintenance manual, the following torques may be used:

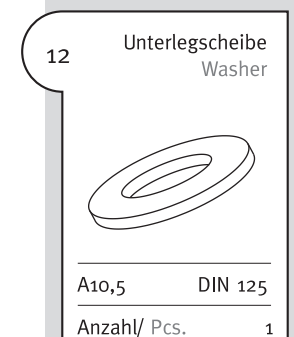
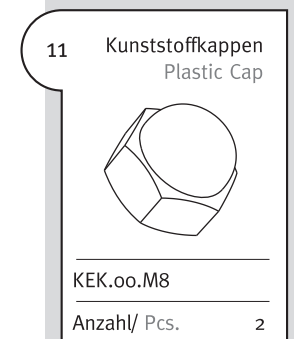
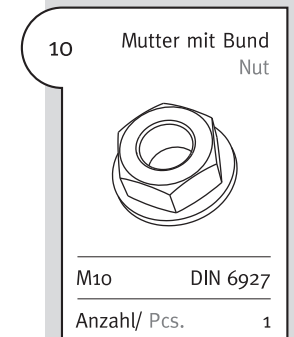
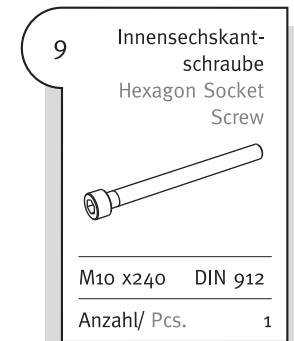
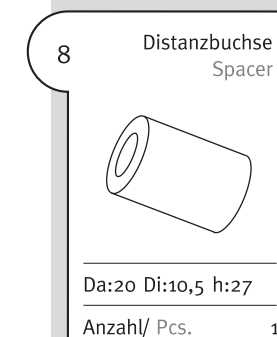
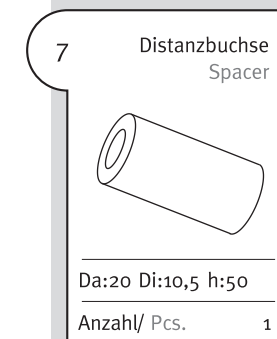
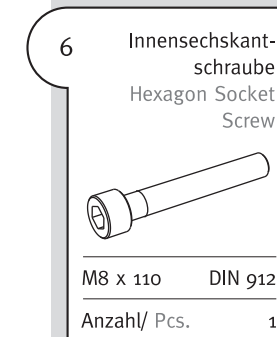
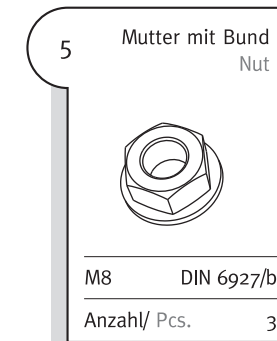
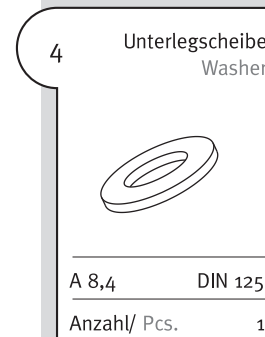
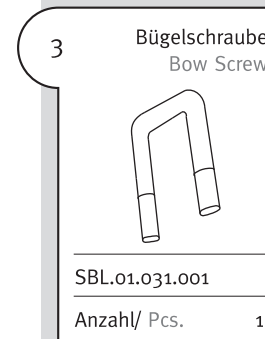
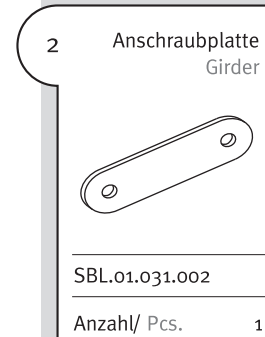
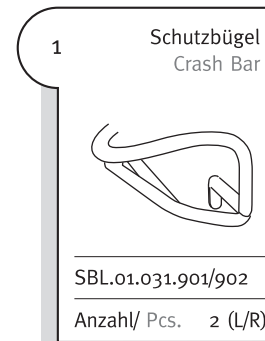

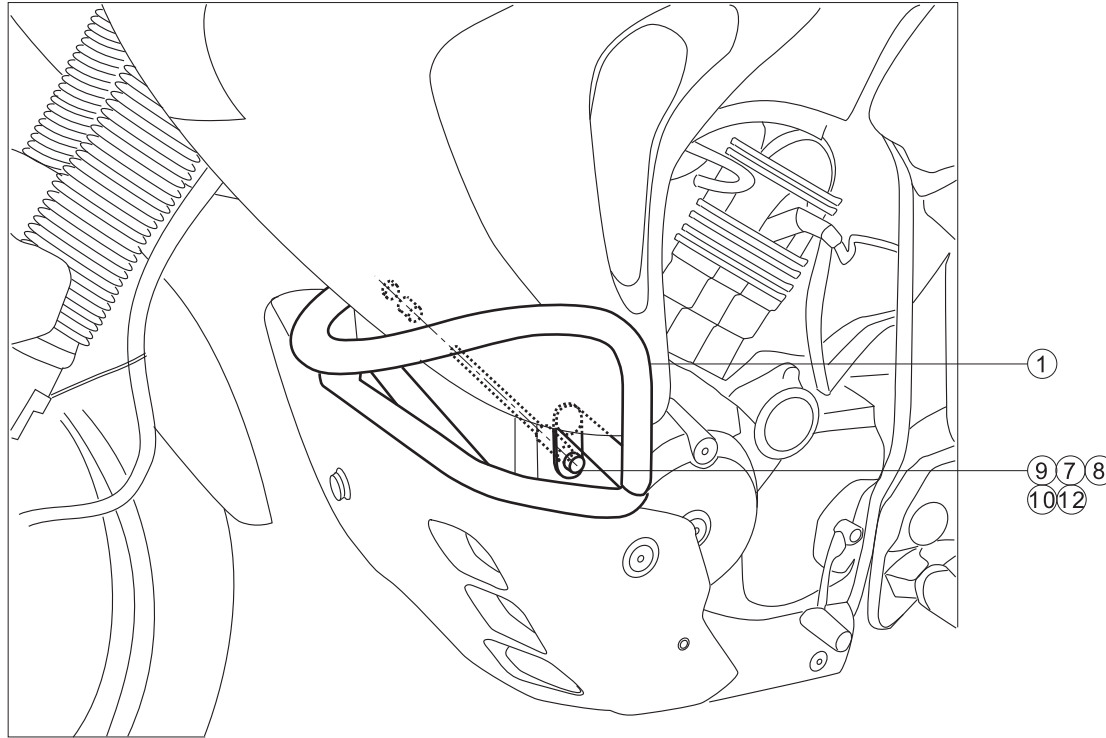

**WARNUNG / ATTENTION**

Achtung: Die Boden- und Schräglagenfreiheit kann bei Nutzung dieses Anbauteils eingeschränkt sein.

Attention: Cornering and ground clearance can be reduced by using this accessory.

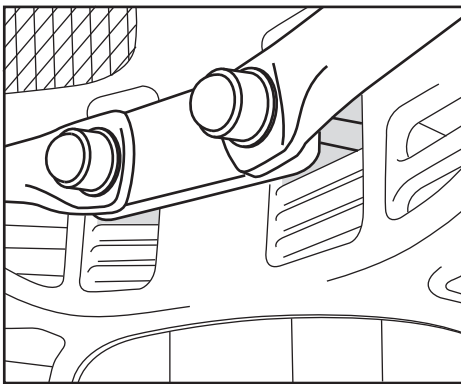
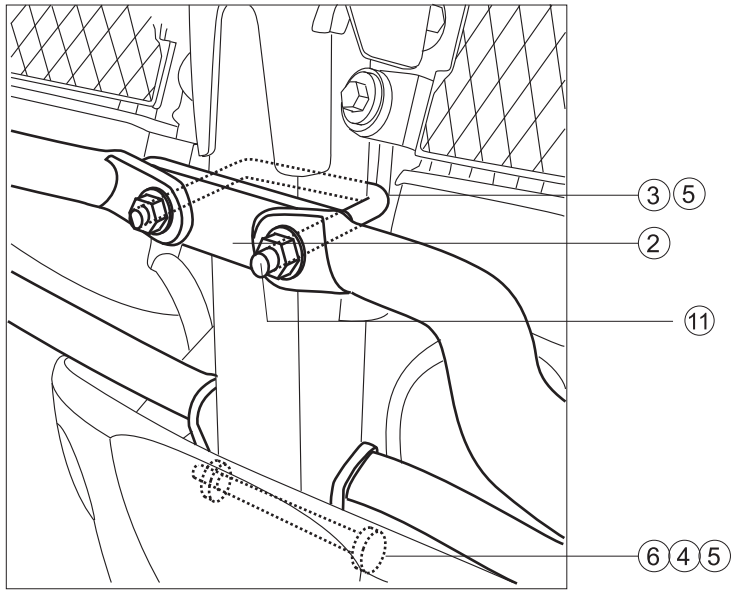

**Wichtig:** an der gezeigten Stelle (grau) müssen in den Kühlerschutz Aussparungen für die Bügelschraube (3) geschaffen werden. Entfernen Sie dazu eine Querstrebe.

**Important:** for the bowscrew (3) you must create a cut out on the shown position (grey).