

Honda Hornet CB 900

Schutzbügel

Montagehinweise

Alle vom Motorrad gelösten Schrauben sind gemäß Herstellerangaben wieder zu montieren, oder mit von SW-MOTECH gelieferten Schrauben zu ersetzen. Falls nicht anderweitig definiert, diese Schrauben nach Tabelle anziehen.

| | |
|-----|--------|
| M6 | 9,6 Nm |
| M8 | 23 Nm |
| M10 | 46 Nm |

Gegebenenfalls Schrauben mit flüssiger Schraubensicherung einkleben.

Prüfen Sie nach 50km alle Verbindungen auf festen Sitz.

SW-MOTECH GmbH & Co. KG
Ernteweg 8/10
35282 Rauschenberg
-Germany-

Tel.: ++ 49 (0) 6425 816 800
Fax: ++ 49 (0) 6425 816 810

www.sw-motech.com

Crash Bar

Mounting Instructions

SW-MOTECH products should be installed by a qualified, experienced motorcycle technician. If you are unsure of your ability to properly install a product, please have the product installed by your local motorcycle dealer. SW-MOTECH takes no responsibility for damages caused by improper installation.





All screws, bolts and nuts, including all replacement hardware provided by SW-MOTECH, should be tightened to the torque specified in the OEM maintenance manual for your motorcycle. If no torque specifications are provided in the OEM maintenance manual, the following torques may be used:

| | |
|-----|--------|
| M6 | 9,6 Nm |
| M8 | 23 Nm |
| M10 | 46 Nm |

All screws, bolts and nuts should be checked after driving the first 50 km to ensure that all are tightened to the proper torque.

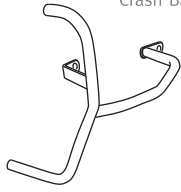
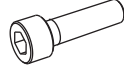
Medium strength liquid thread-locker (i.e., "Loctite") should be used to secure all screws, bolts and nuts.

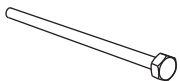
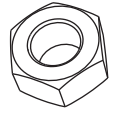

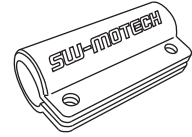
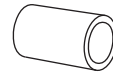
| | | |
|---|--|--|
| <p>1 Schutzbügel Crash Bar</p>  <p>SBL.01.113.901/902 00</p> <p>Anzahl/ Pcs. 2 (L/R)</p> | <p>5 Innensechskantschraube Hexagon Socket Screw</p>  <p>M6 x 20 DIN 912</p> <p>Anzahl/ Pcs. 2</p> | <p>9 Distanzbuchse Spacer</p>  <p>Da:20 Di:10,2 h:70</p> <p>Anzahl/ Pcs. 1</p> |
| <p>2 Sechskantschraube Hexagon Screw</p>  <p>M10 x 330 DIN 931</p> <p>Anzahl/ Pcs. 1</p> | <p>6 Mutter selbstsichernd Lock Nut</p>  <p>M6 DIN 985</p> <p>Anzahl/ Pcs. 2</p> | |
| <p>3 Mutter mit Bund Lock Nut</p>  <p>M10 DIN 6927</p> <p>Anzahl/ Pcs. 1</p> | <p>7 Rahmenendkappen Plastic Cap</p>  <p>KES.00.20.02/b</p> <p>Anzahl/ Pcs. 2</p> | |
| <p>4 Klemmschelle Clamp</p>  <p>SBL.01.051.002/b 01</p> <p>Anzahl/ Pcs. 1</p> | <p>8 Distanzbuchse Spacer</p>  <p>Da:20 Di:10,2 h:35</p> <p>Anzahl/ Pcs. 1</p> | |

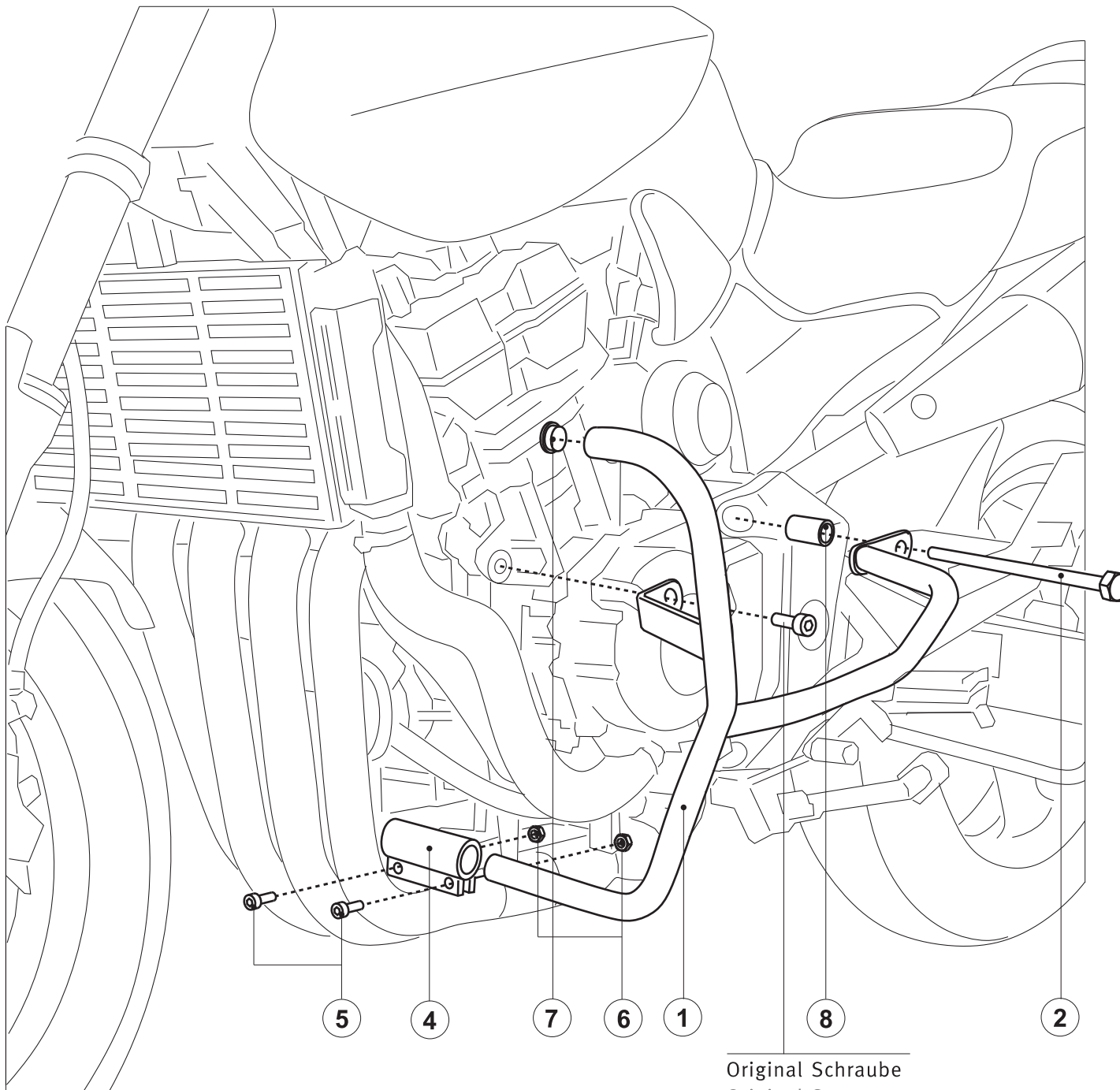

Original Schraube
Original Screw



WARNUNG / ATTENTION
Achtung: Die Boden- und Schräglagenfreiheit kann bei Nutzung dieses Anbauteils eingeschränkt sein.
Attention: Cornering and ground clearance can be reduced by using this accessory.

3

9