

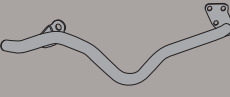











TN21090X - KN21090X

PARAMOTORE SPECIFICO - SPECIFIC ENGINE GUARD - PARE-CARTER SPECIFIQUE SPEZIFISCHER STURZBÜGEL - DEFENSA DE MOTOR ESPECÍFICA

YAMAHA FJR1300 (2013)

N°	Descrizione	Caratteristiche	Codice	Quantità	
1	Paramotore - Engine Guard Pare-carter - Sturzbuegel Defensa De Moto	Dx	-	1	
2	Supporto - Support Support - Halter - Soporte	Sx	-	1	
3	Distanziale - Spacer Entretoise - Distanzstueck - Distanciador	Ø22x4mm Foro 12.5mm	GL2265	1	
4	Distanziale - Spacer Entretoise - Distanzstueck - Distanciador	Ø22x4mm Foro 10.5mm	GL2266	1	
5	Distanziale - Spacer Entretoise - Distanzstueck - Distanciador	Ø22x5mm Foro 12.5mm	GL2270	3	
6	Vite - Screw Vis - Schraube Tornillo	TCEI M8x30mm	830TEF	2	
7	Vite - Screw Vis - Schraube Tornillo	TCEI M10x30mm	1030TEF	1	
8	Vite - Screw Vis - Schraube Tornillo	TEF M10x245	10245TEF	1	
9	Vite - Screw Vis - Schraube Tornillo	TCEI M12x75 passo 1.25		1	
10	Vite - Screw Vis - Schraube Tornillo	TCEI M12x65 passo 1.25		1	
11	Rondella - Washer Rondelle - Scheibe Arandela	Ø8mm	8RON	2	
12	Rondella - Washer Rondelle - Scheibe Arandela	Ø10mm	10RON	1	
13	Rondella - Washer Rondelle - Scheibe Arandela	Ø12mm	12RON	2	
14	Componenti originali - Original parts Parties originales - Original bauteile Componentes originales	-	-	-	-

TN21090X - KN21090X

PARAMOTORE SPECIFICO - SPECIFIC ENGINE GUARD - PARE-CARTER SPECIFIQUE SPEZIFISCHER STURZBÜGEL - DEFENSA DE MOTOR ESPECÍFICA

YAMAHA FJR1300 (2013)

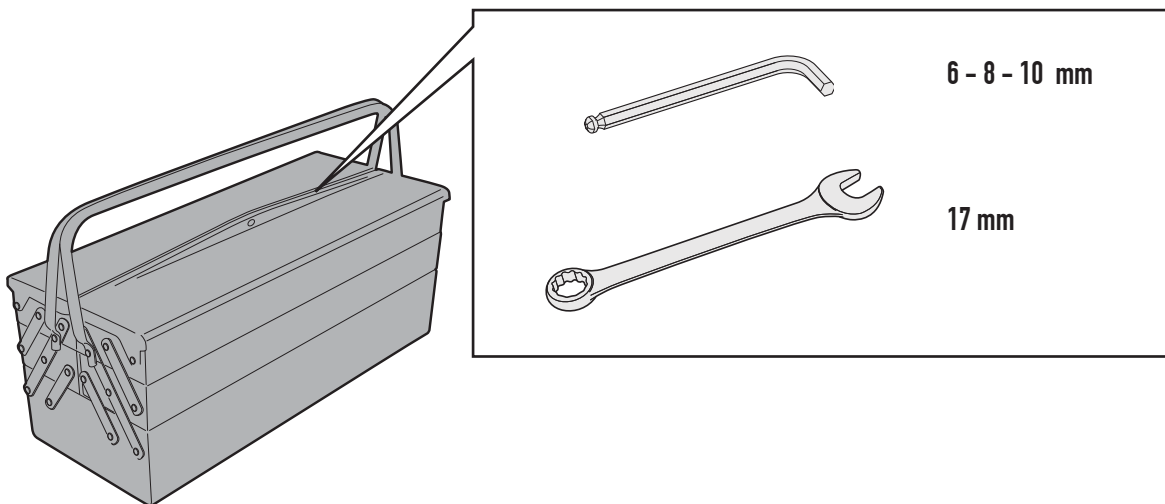

TN21090X - KN21090X

PARAMOTORE SPECIFICO - SPECIFIC ENGINE GUARD - PARE-CARTER SPECIFIQUE SPEZIFISCHER STURZBÜGEL - DEFENSA DE MOTOR ESPECÍFICA

YAMAHA FJR1300 (2013)

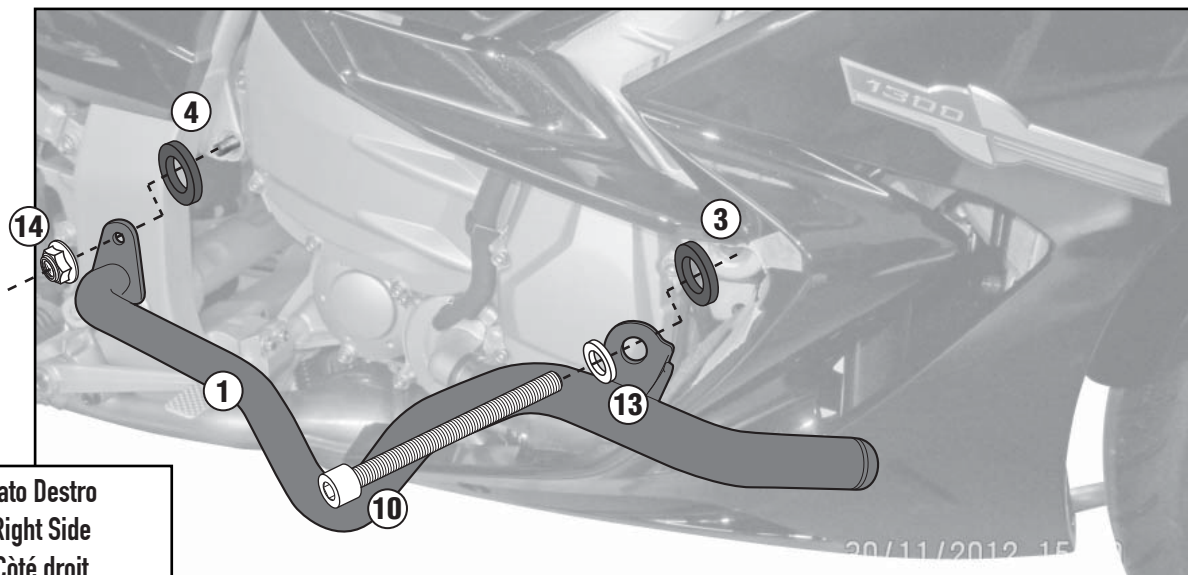

Lato Destro
Right Side
Côté droit
Rechte Seite
Lado derecho

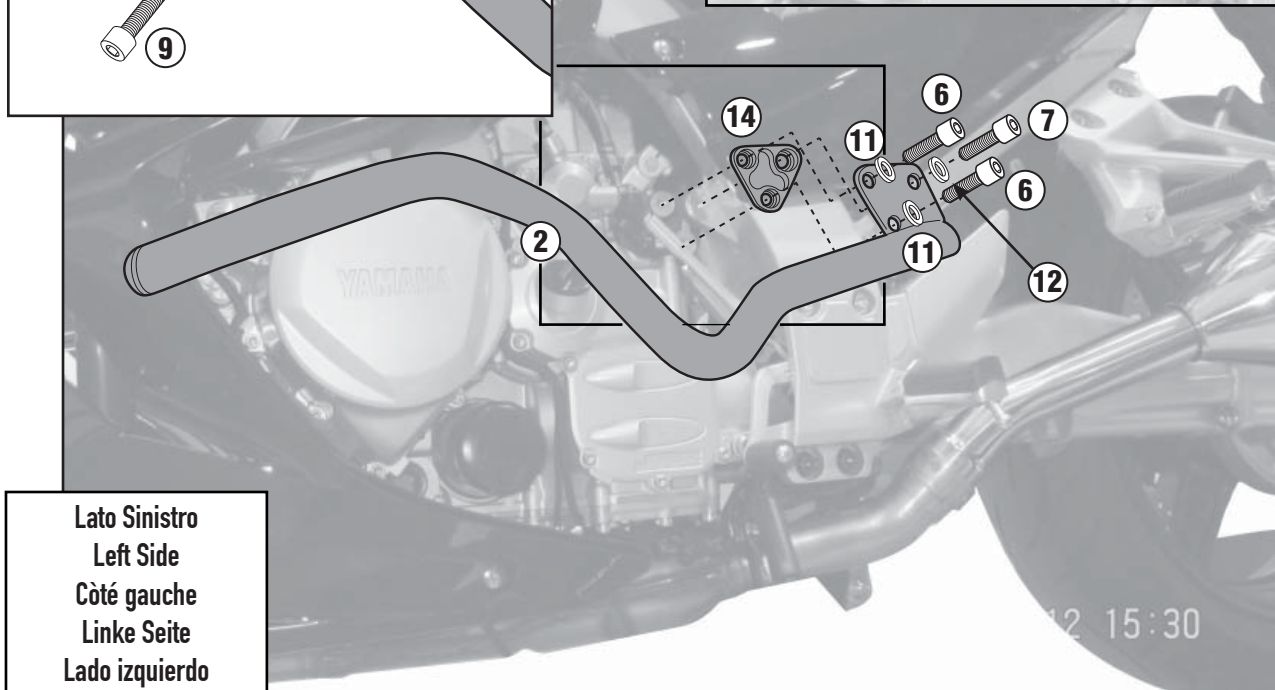
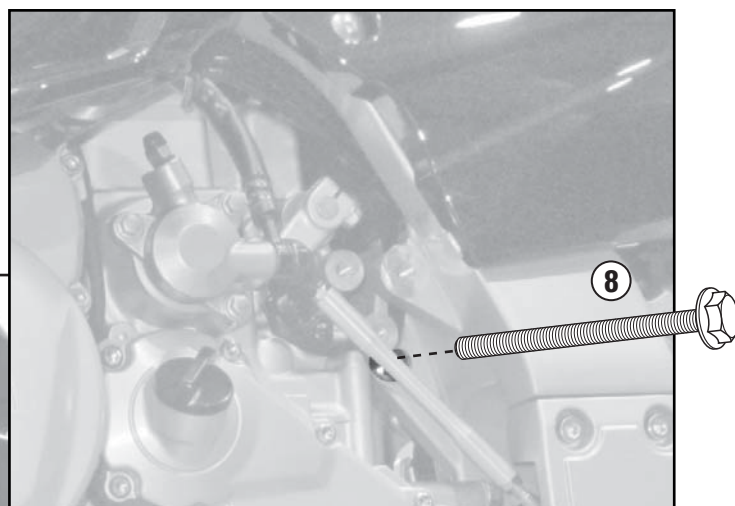
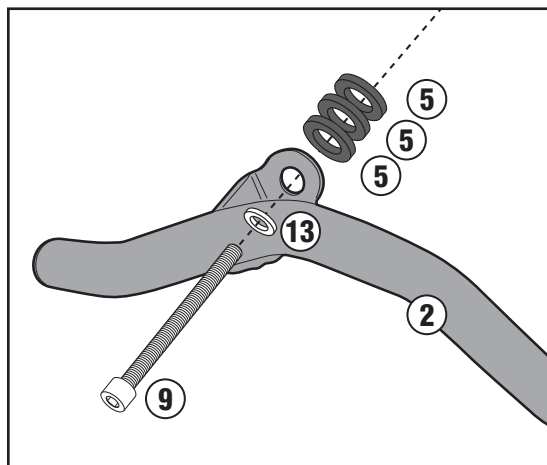

Lato Sinistro
Left Side
Côté gauche
Linke Seite
Lado izquierdo