

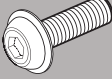



A1102 - A1102

ATTACCHI SPECIFICI - SPECIFIC FITTING KIT FOR - KIT DE MONTAGE SPECIFIQUE POUR - SPEZIFISCHER MONTAGEKIT FÜR - ANCLAJE ESPECÍFICO PARA

HONDA HORNET 600 2011

N°	Descrizione	Caratteristiche	Codice	Quantità	
1	Supporto - Support - Support Halterung - Soporte	-	-	2 (Dx,Sx)	
2	Vite - Screw Vis - Schraube Tornillo	TBEIFN M6x16mm	-	4	
3	Rondella in Nylon - Nylon washer Rondelle original en Nylon - Nylonscheibe Arandela de Nylon	-	Z1979	4	
4	Rondella in gomma - Rubber washer Rondelle en gomme - Gummischeibe Arandela de goma	-	ORONG	4	
5	Dado - Bolt - Erou Mutter M6 - Tuerca	Auto Bloccante Flangiato M6	-	4	
6				1	
7	Componenti originali - Original parts Parties originales - Original bauteile Componentes originales	-	-	-	-

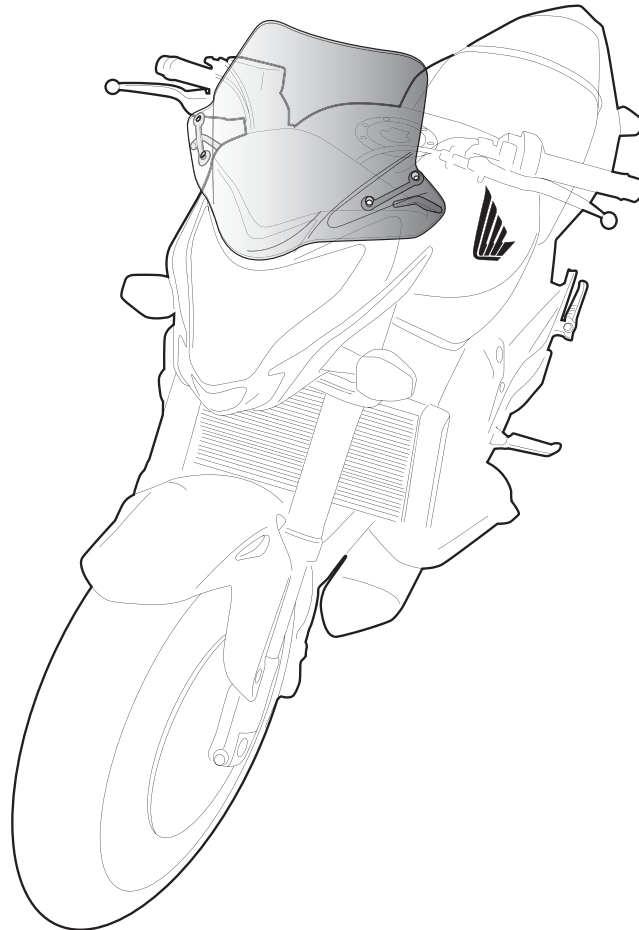

A1102 - A1102

ATTACCHI SPECIFICI - SPECIFIC FITTING KIT FOR - KIT DE MONTAGE SPECIFIQUE POUR - SPEZIFISCHER MONTAGEKIT FÜR - ANCLAJE ESPECÍFICO PARA

HONDA HORNET 600 2011

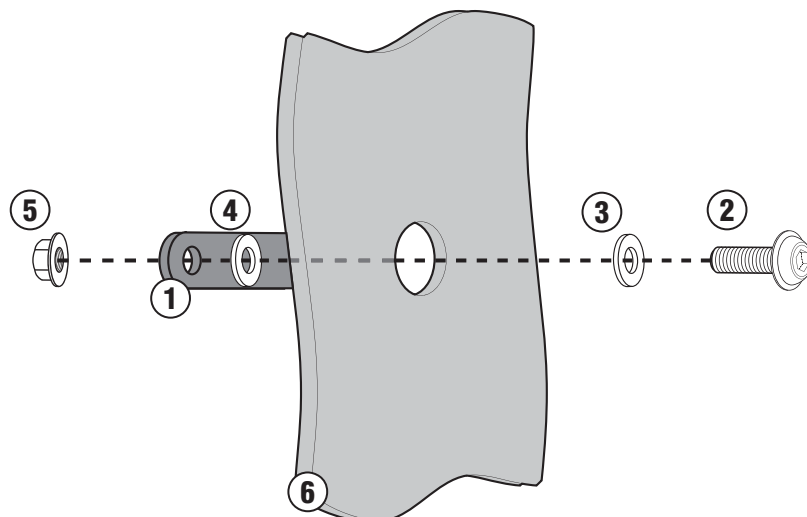

ISTRUZIONI DI MONTAGGIO - MOUNTING INSTRUCTIONS
INSTRUCTIONS DE MONTAGE - BAUANLEITUNG - INSTRUCCIONES
DE MONTAJE