

## Hauptständer Centre Stand

## HONDA VT 750 C/C2 Shadow - Black Widow

### Montagehinweise

Alle vom Motorrad gelösten Schrauben sind gemäß Herstellerangaben wieder zu montieren, oder mit von SW-MOTECH gelieferten Schrauben zu ersetzen. Falls nicht anderweitig definiert, diese Schrauben nach Tabelle anziehen.

M6	9,6 Nm
M8	23 Nm
M10	46 Nm

Gegebenenfalls Schrauben mit flüssiger Schraubensicherung einkleben.

Prüfen Sie nach 50km alle Verbindungen auf festen Sitz.

Die Kurvenfreiheit kann durch einen Hauptständer eingeschränkt werden

SW-MOTECH GmbH & Co. KG  
Ernteweg 8/10  
35282 Rauschenberg  
Germany

Tel. +49 (0) 64 25/8 16 8-00  
Fax +49 (0) 64 25/8 16 8-10

info@sw-motech.com  
www.sw-motech.com

### Mounting Instructions

Centerstand cornering clearance:  
SW-MOTECH centerstands are carefully designed and tested to eliminate reductions in cornering clearance and ground clearance under most driving conditions on an unmodified stock motorcycle, and are certified to be compliant with European ABE safety standards. Use of any centerstand may reduce cornering clearance or ground clearance under extreme driving situations.









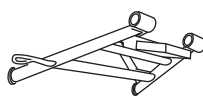
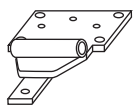
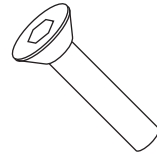

SW-MOTECH products should be installed by a qualified, experienced motorcycle technician. If you are unsure of your ability to properly install a product, please have the product installed by your local motorcycle dealer. SW-MOTECH takes no responsibility for damages caused by improper installation.

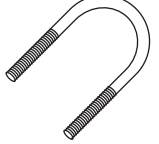
All screws, bolts and nuts, including all replacement hardware provided by SW-MOTECH, should be tightened to the torque specified in the OEM maintenance manual for your motorcycle. If no torque specifications are provided in the OEM maintenance manual, the following torques may be used:

M6	9,6 Nm
M8	23 Nm
M10	46 Nm

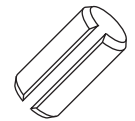
All screws, bolts and nuts should be checked after driving the first 50 km to ensure that all are tightened to the proper torque.

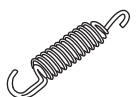
Medium strength liquid thread-locker (i.e., "Loctite") should be used to secure all screws, bolts and nuts.

<p><b>1</b> Hauptständer Centre Stand</p>  <p>HPS.01.049.910 Anzahl/ Pcs. 1</p>	<p><b>5</b> Aufnahmeplatte Mounting Plate</p>  <p>HPS.01.049.903 Anzahl/ Pcs. 1</p>	<p><b>9</b> Senkkopfschraube Countersunk Screw</p>  <p>M8 x 70 DIN 7991 Anzahl/ Pcs. 1</p>
<p><b>2</b> Steckachse Rod</p>  <p>HPS.01.049.002 Anzahl/ Pcs. 1</p>	<p><b>6</b> Bügelschraube Bow Screw</p>  <p>E43 H68 Anzahl/ Pcs. 2</p>	<p><b>10</b> Mutter, selbstsichernd Lock Nut</p>  <p>M8 DIN 985 Anzahl/ Pcs. 2</p>
<p><b>3</b> Unterlegscheibe Washer</p>  <p>A 17 DIN 125 Anzahl/ Pcs. 1</p>	<p><b>7</b> Mutter mit Bund Lock Nut</p>  <p>M8 DIN 6927/b Anzahl/ Pcs. 4</p>	<p><b>11</b> Spannstift Split Pin</p>  <p>D5 x 12 DIN 1482 Anzahl/ Pcs. 2</p>
<p><b>4</b> Splint Splint</p>  <p>D3,2 x 25 DIN 94 Anzahl/ Pcs. 1</p>	<p><b>8</b> Zugfedersatz Spring-Set</p>  <p>ZFD.00.150.003 Anzahl/ Pcs. 1</p>	<p><b>12</b> Gummidämpfer Damper</p>  <p>MSS.00.03.016 Anzahl/ Pcs. 1</p>

## Allgemeine Betriebserlaubnis (ABE)

Sollte Ihnen das ABE-Dokument zu diesem Artikel nicht mehr vorliegen, können Sie dieses auf unserer Internetseite unter der jeweiligen Artikelnummer finden: [www.sw-motech.com](http://www.sw-motech.com)

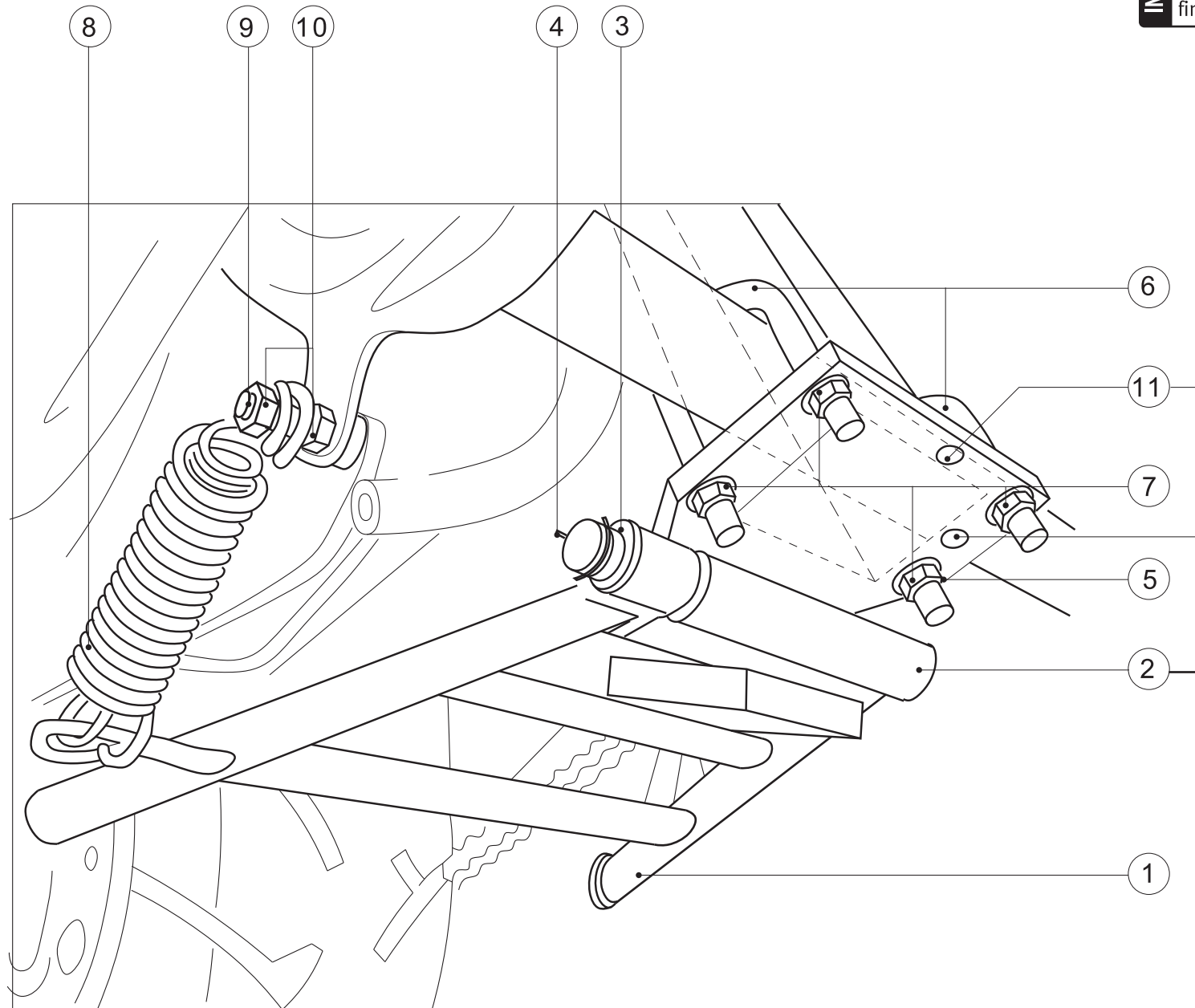

**!** Mit Fett einsetzen  
Insert with grease 

**!** Achtung:  
Die Kurven- und Bodenfreiheit kann durch einen Hauptständer eingeschränkt werden  
  
Attention:  
Cornering and ground clearance can be reduce by using a centre stand